

INDEX

Page Number

New Water Pumpsii
Discontinued Itemsii
Available Fan Clutch Itemsii
High Performance Water Pumps.iii
New GMB Water Pumps and Fan Clutchesiv
Common Water Pump Failures (Troubleshooting)vi
New Water Pump Installation Instructions.vii
Fan Clutch Installation Instructionsvii
Alphabetical / Application Listing	1
Buyer's Guide Numerical Listing	23
Interchange – OEM Number to Our Number.	30
Interchange – Competitor (Water Pumps) to Our Number	31
Water Pump Pictures	34

MAKE/MODEL INDEX

MAKE	Part Code	Page No.	MAKE	Part Code	Page No.	MAKE	Part Code	Page No.
Acura	135	1	Hummer	130	12	Scion	170	18
Audi	180	1	Hyundai	146/148	12	Subaru	160	18
BMW	115	1	Infiniti	150	13	Suzuki	165	19
Buick	130	2	Isuzu Truck	130	13	Suzuki Truck	165	19
Cadillac	130	2	Jaguar	113/125	13	Toyota	130/170	19
Chevrolet	130	2	Jeep	120	13	Toyota Truck	170	20
Chevrolet Truck	130	3	Kia	143/146	13	Volkswagen	180	20
Chevrolet Truck Medium & Heavy Duty	130	6	Kia Truck	146	14	Volvo	190	21
Chrysler	120/130/148	7	Lexus	170	14			
Chrysler Truck	120	7	Lincoln	125	14			
Cummins Diesel	196	7	Mazda	125/145	15			
Dodge	120/148	7	Mazda Truck	125/145	15			
Dodge Truck	120	7	Mercedes Benz	147	15			
Ford	125	8	Mercury	125	16			
Ford Truck	125	8	Mercury Truck	125	16			
GMC Truck	130	10	Mitsubishi	148	16			
GMC Truck Medium & Heavy Duty	130	12	Mitsubishi Truck	125	16			
Honda	135	12	Nissan	150	17			
Honda Truck	135	12	Nissan Truck	150	17			
			Pontiac	130/170	17			
			Saturn	130	18			

IMPORTANT NOTICE

The data listed herein is correct to the best of our knowledge and belief, having been compiled from reliable and official sources of information. However, we cannot assume any responsibility for possible errors.

New Part Numbers Introduced in this Catalog

New Part Numbers	Year	Make	Cyl.	Engine
113-2120	1997-94	JAGUAR	6	4.0L
125-5721	1996-94	FORD LIGHT DUTY TRUCKS	V-8	7.3L
125-6040	2005-03	JAGUAR, LINCLON	V-6	3.0L
130-5130	2006-04	BUICK, CADILLAC	V-6	3.6L
130-5980	2005-01	CHEVROLET, GMC LIGHT DUTY TRUCKS	V-8	6.6L
130-7341	2006-04	BUICK, CADILLAC, CHEVROLET, GMC LD TRUCKS	V-8	4.8L, 5.3L, 6.0L
135-1500	2004-03	ACURA, HONDA	4	2.4L
135-1510	2005-02	ACURA	4	2.0L
135-1520	2005-02	ACURA, HONDA	4	2.0L, 2.4L
135-1530	2004-03	ACURA, HONDA	V-6	3.0L, 3.2L, 3.5L
148-1780	2004-03	MINISUBISHI	4	2.0L, 2.4L
148-1790	2004-01	MINISUBISHI	V-6	3.5L, 3.8L
148-1810	2003	MINISUBISHI LIGHT DUTY TRUCKS	4	2.4L
170-2107	1995-88	TOYOTA	4	2.0L
170-3310	2004	TOYOTA LIGHT DUTY TRUCKS	4	2.4L, 2.7L

Discontinued Items

140-1192	Fan Clutch
150-1112	Fan Clutch
170-1352	Fan Clutch
170-1402	Fan Clutch
170-2083	Fan Clutch
170-1262	Fan Clutch
170-1392	Fan Clutch
113-2030	Water Pump
113-2040	Water Pump
123-2050	Water Pump
125-2020	Water Pump
144-2001	Water Pump
144-2007	Water Pump
144-2009	Water Pump
145-1190	Water Pump
145-2010	Water Pump
145-2501	Water Pump
145-2502	Water Pump
145-2503	Water Pump
150-2500	Water Pump
156-2020	Water Pump
157-2020	Water Pump
158-2030	Water Pump
170-1402	Water Pump
170-2822	Water Pump

Available Fan Clutch Items

Fan Clutch	for	Water Pump
150-1162	for	150-1160
170-1312	for	170-1310
170-1322	for	170-1320
170-1542	for	170-1540



Performance Series

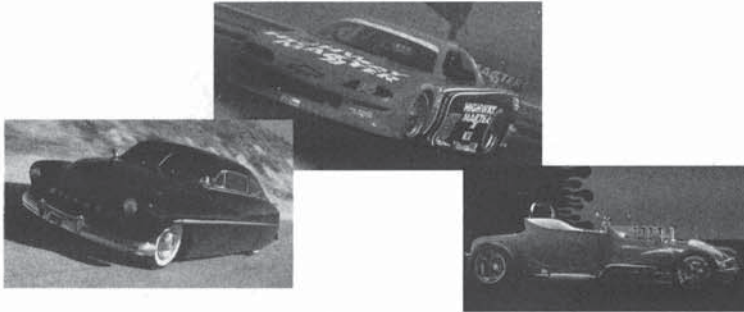

High performance impeller eliminates cavitation at all RPM's

Precision ground, heavy duty steel bearing that's completely sealed and lubed for life

Up to 300% increase in pump pressure

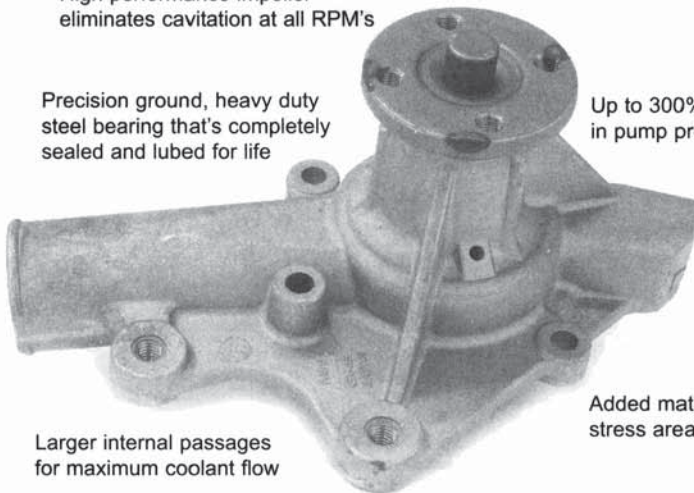

Larger internal passages for maximum coolant flow

Added material in critical stress areas for long life

Water Pumps built to beat the heat

GMB Performance Series Water Pumps are designed and built to combat engine overheating associated with higher performance and load applications. GMB High Performance Water Pumps feature a precision ground, heavy duty steel bearing that's completely sealed and lubed for life. A specially modified, high performance impeller eliminates cavitation at all RPM's, and maintains maximum volumetric flow of coolant throughout the engine.

Additional features of GMB Performance Series Water Pumps are:

- Increase pump pressure up to 300%
- Eliminates steam pockets trapped inside the engine block
- Reduces engine temperature by 15-30 degrees
- Increase horsepower

Incredibly efficient. Built to survive. Features every performance enthusiast can appreciate. GMB, the clear choice for true high performance water pumps.

For **Performance Series Water Pump** applications, refer to catalog under vehicle listing, then, using the chart below, cross reference the *Standard Pump* part number to the *Performance Pump* part number.

PERFORMANCE SERIES PUMP	STANDARD PUMP	PERFORMANCE SERIES PUMP	STANDARD PUMP	PERFORMANCE SERIES PUMP	STANDARD PUMP
* 110-1010P	110-1010	125-1270P	125-1270	130-1220P	130-1220
110-1030P	110-1030	* 125-1350P	125-1350	* 130-1250P	130-1250
110-1040P	110-1040	125-1370P	125-1370	130-1260P	130-1260
110-1050P	110-1050	125-1420P	125-1420	* 130-1270P	130-1270
110-1060P	110-1060	* 125-1440P	125-1440	130-1280P	130-1280
110-1070P	110-1070	125-1560P	125-1560	* 130-1310P	130-1310
110-1080P	110-1080	125-1570P	125-1570	130-1320P	130-1320
110-1090P	110-1090	125-1670P	125-1670	130-1350P	130-1350
120-1070P	120-1070	125-1700P	125-1700	* 130-1360P	130-1360
120-1200P	120-1200	125-1800P	125-1800	130-1560P	130-1560
* 120-1250P	120-1250	125-1820P	125-1820	* 130-1620P	130-1620
120-3020P	120-3020	125-1850P	125-1850	* 130-1690P	130-1690
120-3041P	120-3041	125-1920P	125-1920	* 130-1700P	130-1700
120-3071P	120-3071	125-1930P	125-1930	* 130-1820P	130-1820
125-1110P	125-1110	125-1940P	125-1940	* 130-1830P	130-1830
125-1230P	125-1230	130-1010P	130-1010	* 130-2981P	130-2981
125-1260P	125-1260	130-1070P	130-1070	* 130-2985P	130-2985

* CAST IRON WITH SPECIAL IMPELLER

New GMB Water Pumps & Fan Clutches

NEW VS. REBUILT WATER PUMPS

The most obvious reason for installing a new GMB water pump is the precision matched manufacturing of every component. GMB water pumps far exceed the quality and performance of the original equipment. That's because GMB engineers, working from OE manufacturer blueprints and sample parts, design GMB water pumps for optimum performance to exceed the life and performance of original equipment. GMB water pumps use superior alloy materials and state-of-the-art manufacturing techniques that guarantee unparalleled precision and superlative operation for the life of your vehicle. That's why, when you choose a GMB water pump, you can be sure it's the last one you'll ever buy for your vehicle. For the money, some people believe that a rebuilt factory water pump is a vehicle alternative to a new GMB replacement water pump. Not True! Think about it. A rebuilt water pump started life as a plain old, OEM pump. It's been rebuilt because it's worn out! In the rebuilding process, many of the old components considered still serviceable are reused. At best, it's a gamble.

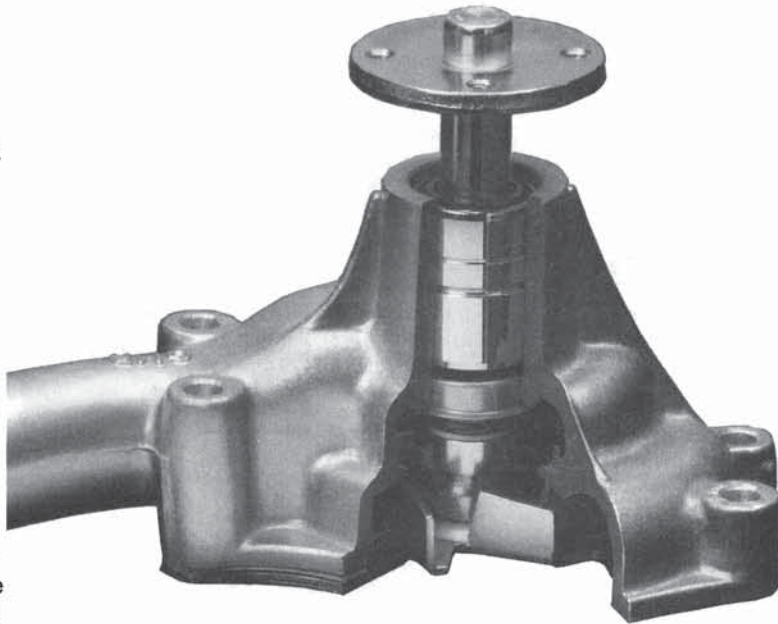

Considering the time and expense of installing a replacement water pump, it just makes good sense to insure that it's the last time you'll ever have to do it. The no risk, GMB water pumps can't be beat.

Cooling System Overview

Radiator

The radiator is responsible for transfer of heat from the circulating coolant to the air passing through it. Heated coolant flows into the top of the radiator from the engine. The coolant is passed through a series of tubes and fins that effectively dissipate the heat in the coolant.

Radiator Cap

Modern radiator caps are actually pressure valves that are responsible for increasing and regulating pressure in the coolant system. Increasing the coolant system pressure raises the boiling point of the coolant. For every additional pound of atmospheric pressure the coolant boiling point increases 3 deg. F.

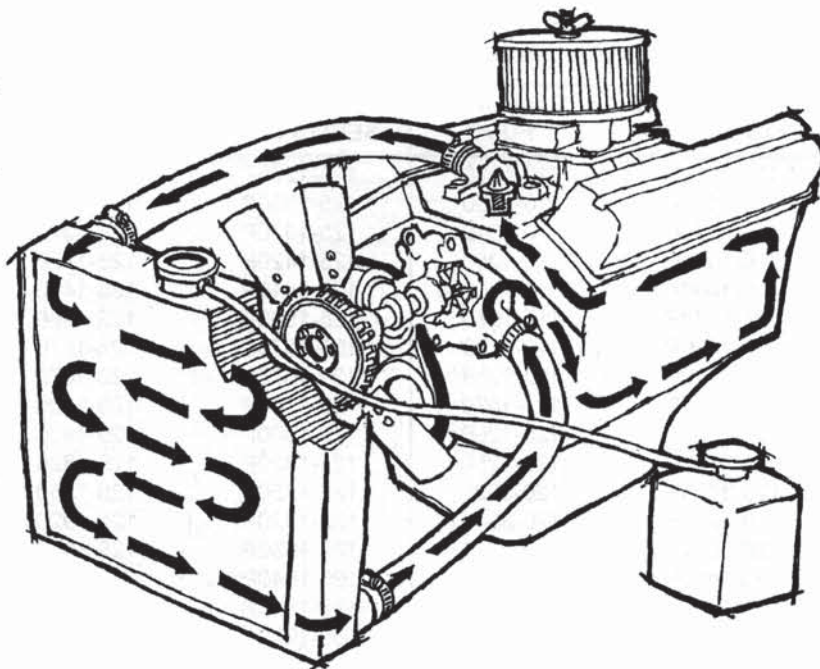

How to tell if a water pump is defective

1. Check for shaft seal failure by carefully inspecting the water pump weep hole. When a water pump is new, some seepage is normal in the initial hours of operation as the seal seats. Other than that, any leakage that occurs is due to seal failure and the pump needs replacement. There may be tell tale trails of rust, calcium and coolant deposits on the water pump housing with the weep hole as the origin.

2. Detect a worn water pump bearing by checking for side-to-side play at the shaft. There should be no perceptible play as you apply hand pressure to the shaft. Accelerated bearing wear is characterized by screeching or rumbling noises coming from the water pump housing. If any of these conditions exist, the bearing is worn out and the pump should be replaced.

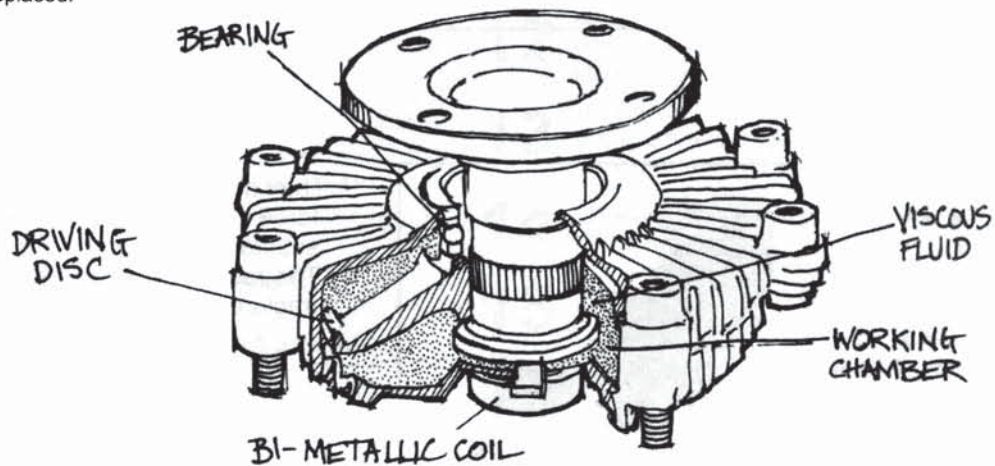

How to tell if a fan clutch is defective

1. Check for oil streaks (or dust collected on oil streaks) on the fan clutch. It's a sure sign that the internal fluid that provides the clutch action is leaking.

2. To check for a worn bearing, grasp the fan blade on either end, with the engine off, and check for lateral movement. If there is more than 1/4" of side-to-side movement, the bearing is worn and the unit needs replacement.

3. In checking for proper fan clutch operation, first run the engine until operating temperature is reached. Next, with the engine off, give the fan blade a gentle spin. If it rotates more than twice the clutch is worn and needs replacing. If fan rotation is rough or noisy, or the fan fails to turn, the unit is worn out and needs replacement.

Coolant

Coolant, flowing through the hot engine, transfers the heat to itself for dissipation in the radiator. In addition to providing improved performance over plain tap water, most leading anti-freeze products contain anti-rust and corrosion additives that prevent sediment build-up and premature cooling system component failure.

Coolant Recovery Tank

The coolant recovery tank serves as a reservoir. It receives coolant expelled from the cooling system through the pressure valve in the radiator cap. It holds the expelled coolant for reintroduction into the cooling system when needed. When additional coolant is needed in the system, it should be added to the recovery tank, not directly to the radiator.

Fan

The fan pulls cool air through the radiator to aid heat-transfer from the coolant.

Fan Clutch

The fan clutch is designed to keep the optimum amount of air flowing through the radiator. At slow vehicle speeds, the fan is

required to move enough air through the radiator to insure proper cooling. At high-way speeds the airflow through the radiator is sufficient to provide proper cooling without the aid of the fan. The clutch lets the fan free wheel at highway speeds, reducing horsepower loss.

Belts

The belts are responsible for driving the water pump, as well as other accessories. Be sure they are in good shape and adjustment, not worn, cracked or slipping. Never over tighten belts. Over tightened belts put unnecessary side-load pressures on the water pump impeller shaft and bearings. Premature water pump failure is inevitable.

Hoses

Radiator hoses are responsible for carrying coolant to and from the engine from the radiator. They should be regularly checked for signs of advanced deterioration, such as bulging and cracking. Healthy hoses should be pliable. Not soft and spongy, or hard and brittle. Any sign of leakage could mean its time for replacement.

Thermostat

The thermostat is responsible for regulating the flow of coolant into the engine block. It keeps the engine block at its optimum operating temperature. When the engine is cold, the thermostat closes to restrict coolant flow and allow the engine to quickly reach a satisfactory operating temperature. As the engine heats up, the thermostat opens and allows more coolant to circulate. A sticky thermostat can stop or restrict coolant flow to the engine.

Water Pump

The water pump delivers a continuous flow of coolant through the radiator and through the engine. A paddle style impeller mounted inside the water pump housing, rotating on a bearing supported shaft, is responsible for moving the coolant. The impeller shaft is driven externally by a pulley/belt combination that's connected to the crankshaft pulley. Keeping the coolant clean and fresh and the belts properly tensioned is about all the maintenance the water pump requires.

Common Water Pump Failures and Their Causes

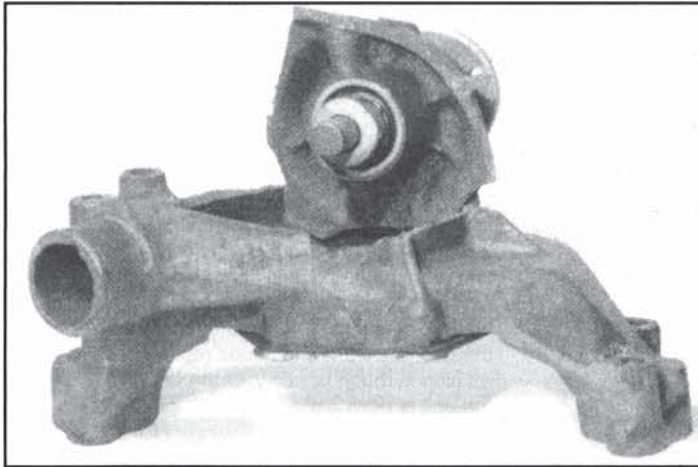

Figure 1

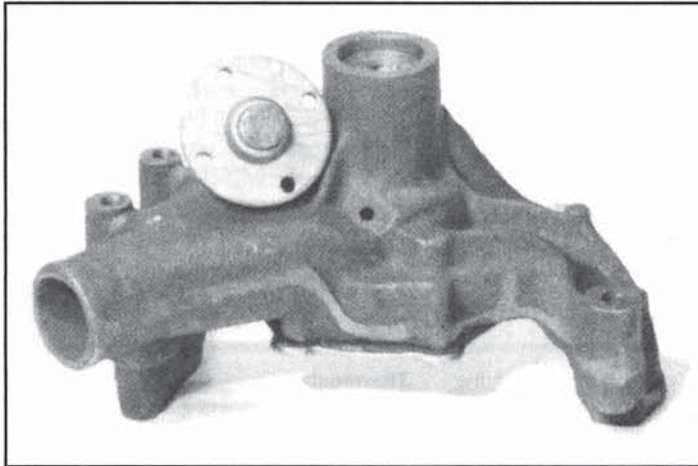

Figure 2

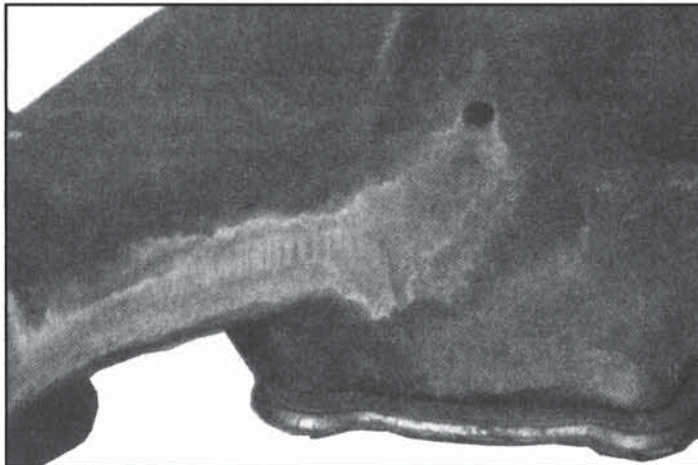

Figure 3

BROKEN WATER PUMP HOUSINGS AND SHAFTS COMMONLY CAUSED BY:

(FIGURES 1 & 2)

Excessive Vibration & Unbalance due to:

- Bent, Cracked or Broken Fan
- Fan not squarely mounted on the shaft
- Cracked or Bent Pulleys due to improper handling or installation.

Belts Too Tight

- Over tightened belts cause over loads on the bearing, greatly reducing its operating life
- They also impose a powerful bending force on the shaft causing it to deflect substantially from true center rotation. The result is large unbalanced and early fracture

SEEPAGE FROM THE WEEP HOLE

(FIGURE 3)

Seepage from the weep hole is a sure sign of seal failure. The life of the seal can be greatly extended by performing regular maintenance on your cooling system. Periodic inspection of hoses and coolant recovery tank will assure coolant levels are correct and that no atmospheric contaminants that can cause oxidation and sludge build-up are present. Sludge build-up in the cooling system is a primary cause of seal failure as well as reduced cooling system efficiency.

NEW WATER PUMP INSTALLATION INSTRUCTIONS:

Heavy duty water pump designed and manufactured for maximum Performance featuring:

Precision ground steel heavy duty bearing sealed and lubed for life.

Unitized seal for maximum protection against leaking.

Vertical breather located under hub, replaces conventional weep hole on some water pumps.

To insure best results, follow these step-by-step instructions:

- 1** Flush cooling system of all sediment, rust & scale before removing old water pump.
- 2** Disconnect fan, fan clutch, hoses and fan belts.
- 3** Remove old water pump, clean impeller cavity in engine block & clean gasket surface
- 4** Tighten steel back plate bolts on water pump where applicable.
- 5** Coat new gaskets on both sides with sealer and position on pump or engine block.
- 6** Install new water pump. **DO NOT STRIKE SHAFT.** This can damage bearings. Tighten bolts evenly in crossing pattern.
- 7** Turn pumps shaft by hand for free rotation.
- 8** Reinstall hoses & belts. Be sure belt & pulley line up.
- 9** Fill radiator with fresh coolant and check for leaks.
- 10** Check fan blades. If bent, cracked or rivets are loose, replace entire fan. Do not try to straighten.
- 11** If equipped with fan clutch, check fan clutch for loss of oil, looseness or wobble. Replace if damaged.
- 12** Install fan clutch. Check that it sits flat on pump hub. Use lock washers & torque bolts evenly for wobble free operation.
- 13** Tighten fan belts to factory recommended tension. Use a commercial tension gauge or adjust belt movement from ½" to ¾" as recommended.
- 14** Check fan clearance at blade tip between shroud and radiator.
- 15** Start engine and run until operating temperature is reached. Check for leaks and smooth operation.
- 16** Shut off engine, let cool, remove radiator cap and top off radiator coolant.

NEW FAN CLUTCH INSTALLATION INSTRUCTIONS:

Heavy duty water pump designed and manufactured for maximum Performance featuring:

- PROVIDES:**
- **Increased Cooling**
 - **Increased Fuel Economy**
 - **Increased Horse Power**

To insure best results, follow these step-by-step instructions:

- 1** Flush cooling system of all sediment, rust & scale.
- 2** Remove fan, fan clutch and fan belts. Check fan blade. If bent, cracked or rivets are loose, replace entire fan. Do not try to straighten.
- 3** Check water pump for leaks or wear. Replace if necessary.
- 4** Mount fan blade squarely on fan clutch and tighten to 15 lbs. of torque.
- 5** Install fan clutch. Check that it sits flat on water pump hub. Use lock washers and tighten to 15 lbs. of torque. Check for wobble free operation and clearance of blade tip between shroud and radiator.
- 6** Install fan belts. Be sure belt and pulley line up. Tighten fan belts to factory recommended tension. Use a commercial tension gauge or adjust belt movement from ½" to ¾" as recommended.
- 7** Fill radiator with fresh coolant and check for leaks.
- 8** Start engine and run until operating temperature is reached. Check for smooth operation.
- 9** Shut off engine, let cool, remove radiator cap and top off radiator coolant.

THIS PAGE WAS INTENTIONALLY LEFT BLANK

				WATER PUMP	
YEAR	MODEL	O.E. NO.	O.E. CASTING	STANDARD	PERFORMANCE
ACURA: CL					
V-6 Engine					
2003-01	3210 (3.2L)	19200-P8A-A02		135-2380	—
ACURA: MDX					
V-6 Engine					
2004-03	3471 (3.5L) J35A5 Inc. Touring	19200-RCA-A01 19200-RDM-A01		135-1530	—
ACURA: NSX					
V-6 Engine					
2005-97	2977 (3.0L)	19200-PR7-A03		135-2085	—
2005-97	3179 (3.2L)	19200-PR7-A03		135-2085	—
ACURA: TL					
V-6 Engine					
2003-99	3210 (3.2L)	19200-P8A-03 19200-P8A-02		135-2380	—
2004	3210 (3.2L)	19200-RDM-A01		135-1530	—
ACURA: TSX					
4 Cylinder					
2004	2354 (2.4L)	19200-RBB-003		135-1500	—
ACURA: RSX					
4 Cylinder					
2005-02	1998 (2.0L)	19200-PNA-003		135-1520	—
2005-02	1998 (2.0L) S	19200-PRB-A01		135-1510	—
ACURA: Vigor					
L-5 Engine					
1994-92	2451 (2.5L)	19200-PV3-003 19200-PV1-A01		135-2090	—
AUDI: A4, A4 Quattro					
4 Cylinder					
2005-01	1800 (1.8L) AMB Turbo	06A-121-011L 06A-121-011T	06A-121-031C 06A-121-019H	180-2220	—
AUDI: A6, A6 Quattro					
V-6 Engine					
2004-00	2671 (2.7L) A6 Quattro Turbo	078-121-006A	078-121-019	180-2240	—
AUDI: Allroad Quattro					
V-8 Engine					
2005-01	2671 (2.7L) Turbo	078-121-006A	078-121-019	180-2240	—
AUDI: TT, TT Quattro					
4 Cylinder					
2005-00	1781 (1.8L)	06A-121-011L 06A-121-011T	06A-121-031C 06A-121-019H	180-2220	—
BMW: 530 Series					
6 Cylinder					
2005-01	3000 (3.0L) 530i, 530iT	1151-7527-910 1151-7503-884		115-2090	—
BMW: X5					
6 Cylinder					
2005-01	2979 (3.0L)	1151-7527-910 1151-7503-884		115-2090	—

				WATER PUMP	
YEAR	MODEL	O.E. NO.	O.E. CASTING	STANDARD	PERFORMANCE
BUICK: Century (Inc. Century Estate Wagon)					
V-6 Engine					
2005-00	189 (3.1L) (J)	12371989	14092225	130-1480	—
BUICK: LeSabre (Inc. LeSabre Estate Wagon)					
V-6 Engine					
2005-96	231 (3.8L) (K, 1)	12537829 12482903	24504920 12564115	130-1780	—
BUICK: Park Avenue (Inc. Park Avenue Ultra)					
V-6 Engine					
2005-96	231 (3.8L) (K, 1)	12537829 12482903	24504920 12564115	130-1780	—
BUICK: Rainier					
6 Cylinder					
2006-04	256 (4.2L) (S)	24576952		130-7700	—
V-8 Engine					
2005-04	323 (5.3L) (M, P)	89017439	12569519	130-7341	—
BUICK: Rendezvous					
V-6 Engine					
2006-04	220 (3.6L) (7)	12566029		130-5130	—
2005-02	207 (3.4L) (E)	12371989	14092225	130-1480	—
CADILLAC: CTS					
V-6 Engine					
2006-04	220 (3.6L) (7)	12566029		130-5130	—
CADILLAC: Deville, Deville Concours					
V-8 Engine					
2005-96	281 (4.6L) (Y, 9)	89017467 12529993		130-1840	—
CADILLAC: Escalade					
V-8 Engine					
2005-04	323 (5.3L) (T)	89017439		130-7341	—
2003-02	323 (5.3L) (T)	12458935		130-7340	—
2005-04	364 (6.0L) (N)	89017439		130-7341	—
2003-02	364 (6.0L) (N)	12458935		130-7340	—
CADILLAC: Hearse					
V-8 Engine					
2005-98	281 (4.6L) (Y, 9)	89017467		130-1840	—
CADILLAC: SRX					
V-6 Engine					
2006-04	220 (3.6L) (7)	12566029		130-5130	—
CADILLAC: STS					
V-6 Engine					
2006-05	220 (3.6L) (7)	12566029		130-5130	—
CHEVROLET: Impala					
V-6 Engine					
2005-00	231 (3.8L) (1, K) Inc. Impala SS	12482903 12537829 12482903	12564115 24504920 12564115	130-1780	—
CHEVROLET: Cavalier (Inc. Cadet)					
4 Cylinder					
2005-02	134 (2.2L) (F)	12591894 12585226	12586485 12583467	130-7350	—

				WATER PUMP	
YEAR	MODEL	O.E. NO.	O.E. CASTING	STANDARD	PERFORMANCE
CHEVROLET: Corvette					
V-8 Engine					
2004-97	350 (5.7L) (G, S)	89017456 88894345	21472033 12557710	130-7290	—
CHEVROLET: Monte Carlo					
V-6 Engine					
2005-98	231 (3.8L) (1, K)	12537829 12482903	24504920 12564115	130-1780	—
CHEVROLET LIGHT DUTY TRUCKS: Astro Van					
V-6 Engine					
2005-96	262 (4.3L) (X)	89017748 12532528	10238199	130-1820	130-1820P
CHEVROLET LIGHT DUTY TRUCKS: Avalanche					
V-8 Engine					
2006-04	323 (5.3L) (T, Z)	89017439		130-7341	—
2003-02	323 (5.3L) (T, Z)	12458935		130-7340	—
2006-02	496 (8.1L) (G)	88893906		130-7260	—
CHEVROLET LIGHT DUTY TRUCKS: Colorado					
4 Cylinder					
2006-04	169 (2.8L) (8)	24576952		130-7700	—
5 Cylinder					
2006-04	211 (3.5L) (6)	24576952		130-7700	—
CHEVROLET LIGHT DUTY TRUCKS: Van Express G1500 - 1/2 Ton					
V-6 Engine					
2006-96	262 (4.3L) (X)	12532528		130-1820	130-1820P
V-8 Engine					
2006-04	294 (4.8L) (V)	89017439		130-7341	—
2006-04	323 (5.3L) (T) w/ 4 Spd. Auto Trans.	89017439		130-7341	—
2006-04	364 (6.0L) (N, U)	89017439		130-7341	—
1998-97	395 (6.5L) (F) Diesel	12534772	12557071	130-7200	—
CHEVROLET LIGHT DUTY TRUCKS: Van Express G2500 - 3/4 Ton					
V-6 Engine					
2006-96	262 (4.3L) (X)	12532528		130-1820	130-1820P
V-8 Engine					
2006-04	294 (4.8L) (V)	89017439		130-7341	—
2006-04	323 (5.3L) (T) w/ 4 Spd. Auto Trans.	89017439		130-7341	—
2006-04	364 (6.0L) (N, U)	89017439		130-7341	—
CHEVROLET LIGHT DUTY TRUCKS: Van Express G3500 - 1 Ton					
V-8 Engine					
2006-04	294 (4.8L) (V)	89017439		130-7341	—
2006-04	323 (5.3L) (T) w/ 4 Spd. Auto Trans.	89017439		130-7341	—
2006-04	364 (6.0L) (N, U)	89017439		130-7341	—
CHEVROLET LIGHT DUTY TRUCKS: Van G1500 - 1/2 Ton					
V-6 Engine					
2006-96	262 (4.3L) (X)	12532528		130-1820	130-1820P
V-8 Engine					
2006-04	294 (4.8L) (V)	89017439		130-7341	—
2006-04	323 (5.3L) (T) w/ 4 Spd. Auto Trans.	89017439		130-7341	—
2006-04	364 (6.0L) (N, U)	89017439		130-7341	—
1998-97	395 (6.5L) (F) Diesel	12534772	12557071	130-7200	—
CHEVROLET LIGHT DUTY TRUCKS: Van G2500 - 3/4 Ton					
V-6 Engine					
2006-96	262 (4.3L) (X)	12532528		130-1820	130-1820P

				WATER PUMP	
YEAR	MODEL	O.E. NO.	O.E. CASTING	STANDARD	PERFORMANCE
CHEVROLET LIGHT DUTY TRUCKS: Van G2500 - 3/4 Ton (Cont.)					
V-8 Engine					
2006-04	294 (4.8L) (V)	89017439		130-7341	—
2006-04	323 (5.3L) (T) w/ 4 Spd. Auto Trans.	89017439		130-7341	—
2006-04	364 (6.0L) (N, U)	89017439		130-7341	—
1998-97	395 (6.5L) (F) Diesel	12534772	12557071	130-7200	—
CHEVROLET LIGHT DUTY TRUCKS: Van G3500 - 1 Ton					
V-6 Engine					
2006-96	262 (4.3L) (X)	12532528		130-1820	130-1820P
V-8 Engine					
2006-04	294 (4.8L) (V)	89017439		130-7341	—
2006-04	323 (5.3L) (T) w/ 4 Spd. Auto Trans.	89017439		130-7341	—
2006-04	364 (6.0L) (N, U)	89017439		130-7341	—
1998-97	395 (6.5L) (F) Diesel	12534772	12557071	130-7200	—
CHEVROLET LIGHT DUTY TRUCKS: Blazer (Compact S10)					
V-6 Engine					
2005-96	262 (4.3L) (X)	12532528	10238199	130-1820	130-1820P
CHEVROLET LIGHT DUTY TRUCKS: S-10 Pickup					
V-6 Engine					
2005-96	262 (4.3L) (X)	12532528	10238199	130-1820	130-1820P
CHEVROLET LIGHT DUTY TRUCKS: SSR					
V-8 Engine					
2006-05	364 (6.0L) (H, U)	89017439	12569519	130-7341	—
CHEVROLET LIGHT DUTY TRUCKS: Pickup Silverado 2WD - 1/2 Ton					
V-6 Engine					
2006-02	262 (4.3L) (X) Flex Fuel	12532528		130-1820	130-1820P
V-8 Engine					
2006-04	294 (4.8L) (V)	89017439		130-7341	—
2006-04	323 (5.3L) (B, T, Z)	89017439		130-7341	—
2006-04	364 (6.0L) (N, U) Inc.1500HD	89017439		130-7341	—
2005-01	400 (6.6L) (1,2) Duramax Diesel	97216136		130-5980	—
2006-01	496 (8.1L) (G) Inc.1500HD	89017693	12574254	130-7260	—
CHEVROLET LIGHT DUTY TRUCKS: Pickup Silverado 2WD - 3/4 Ton					
V-6 Engine					
2006-02	262 (4.3L) (X) Flex Fuel	12532528		130-1820	130-1820P
V-8 Engine					
2006-04	294 (4.8L) (V)	89017439		130-7341	—
2006-04	323 (5.3L) (B, T, Z)	89017439		130-7341	—
2006-04	364 (6.0L) (N, U) Inc.2500HD	89017439		130-7341	—
2005-01	400 (6.6L) (1, 2) Duramax Diesel	97216136		130-5980	—
2006-01	496 (8.1L) (G) Inc.2500HD	89017693	12574254	130-7260	—
CHEVROLET LIGHT DUTY TRUCKS: Pickup Silverado 2WD - 1 Ton					
V-8 Engine					
2006-04	294 (4.8L) (V)	89017439		130-7341	—
2006-04	323 (5.3L) (B, T, Z)	89017439		130-7341	—
2006-04	364 (6.0L) (N, U)	89017439		130-7341	—
2005-01	400 (6.6L) (1, 2) Duramax Diesel	97216136		130-5980	—
2006-01	496 (8.1L) (G)	89017693	12574254	130-7260	—
CHEVROLET LIGHT DUTY TRUCKS: Pickup Silverado 4WD - 1/2 Ton					
V-6 Engine					
2006-02	262 (4.3L) (X) Flex Fuel	12532528		130-1820	130-1820P

				WATER PUMP	
YEAR	MODEL	O.E. NO.	O.E. CASTING	STANDARD	PERFORMANCE
CHEVROLET LIGHT DUTY TRUCKS: Pickup Silverado 4WD - 1/2 Ton (Cont.)					
V-8 Engine					
2006-04	294 (4.8L) (V)	89017439		130-7341	—
2006-04	323 (5.3L) (B, T, Z)	89017439		130-7341	—
2006-04	364 (6.0L) (N, U) Inc.1500HD	89017439		130-7341	—
2005-01	400 (6.6L) (1, 2) Duramax Diesel	97216136		130-5980	—
2006-01	496 (8.1L) (G) Inc.1500HD	89017693	12574254	130-7260	—
CHEVROLET LIGHT DUTY TRUCKS: Pickup Silverado 4WD - 3/4 Ton					
V-6 Engine					
2006-02	262 (4.3L) (X) Flex Fuel	12532528		130-1820	130-1820P
V-8 Engine					
2006-04	294 (4.8L) (V)	89017439		130-7341	—
2006-04	323 (5.3L) (B, T, Z)	89017439		130-7341	—
2006-04	364 (6.0L) (N, U) Inc.2500HD	89017439		130-7341	—
2005-01	400 (6.6L) (1, 2) Duramax Diesel	97216136		130-5980	—
2006-01	496 (8.1L) (G) Inc.2500HD	89017693	12574254	130-7260	—
CHEVROLET LIGHT DUTY TRUCKS: Pickup Silverado 4WD - 1 Ton					
V-8 Engine					
2006-04	294 (4.8L) (V)	89017439		130-7341	—
2006-04	323 (5.3L) (B, T, Z)	89017439		130-7341	—
2006-04	364 (6.0L) (N, U)	89017439		130-7341	—
2005-01	400 (6.6L) (1, 2) Duramax Diesel	97216136		130-5980	—
2006-01	496 (8.1L) (G)	89017693	12574254	130-7260	—
CHEVROLET LIGHT DUTY TRUCKS: Suburban C10 / C1500 - 1/2 Ton 2WD					
V-8 Engine					
2006-04	323 (5.3L) (T, Z)	89017439		130-7341	—
2006-04	364 (6.0L) (U)	89017439		130-7341	—
1994-92	379 (6.2L) (C, J)	88894044	23500372	130-1830	—
2005-01	400 (6.6L) (1, 2) Duramax Diesel	97216136		130-5980	—
2006-01	496 (8.1L) (G)	89017693	12574254	130-7260	—
CHEVROLET LIGHT DUTY TRUCKS: Suburban C20 / C2500 - 3/4 Ton 2WD					
V-8 Engine					
2006-04	323 (5.3L) (T, Z)	89017439		130-7341	—
2006-04	364 (6.0L) (U)	89017439		130-7341	—
1994-92	379 (6.2L) (C, J)	88894044	23500372	130-1830	—
2005-01	400 (6.6L) (1, 2) Duramax Diesel	97216136		130-5980	—
2006-01	496 (8.1L) (G)	89017693	12574254	130-7260	—
CHEVROLET LIGHT DUTY TRUCKS: Suburban K10 / K1500 - 1/2 Ton 4WD					
V-8 Engine					
2006-04	323 (5.3L) (T, Z)	89017439		130-7341	—
2006-04	364 (6.0L) (U)	89017439		130-7341	—
1994-92	379 (6.2L) (C, J)	88894044	23500372	130-1830	—
2005-01	400 (6.6L) (1, 2) Duramax Diesel	97216136		130-5980	—
2006-01	496 (8.1L) (G)	89017693	12574254	130-7260	—
CHEVROLET LIGHT DUTY TRUCKS: Suburban K20 / K2500 - 3/4 Ton 4WD					
V-8 Engine					
2006-04	323 (5.3L) (T, Z)	89017439		130-7341	—
2006-04	364 (6.0L) (U)	89017439		130-7341	—
1994-92	379 (6.2L) (C, J)	88894044	23500372	130-1830	—
2005-01	400 (6.6L) (1, 2) Duramax Diesel	97216136		130-5980	—
2006-01	496 (8.1L) (G)	89017693	12574254	130-7260	—
CHEVROLET LIGHT DUTY TRUCKS: Suburban R10 / R1500 - 1/2 Ton 2WD					
V-8 Engine					
2006-04	323 (5.3L) (T, Z)	89017439		130-7341	—
2006-04	364 (6.0L) (U)	89017439		130-7341	—
1994-92	379 (6.2L) (C, J)	88894044	23500372	130-1830	—
2005-01	400 (6.6L) (1, 2) Duramax Diesel	97216136		130-5980	—
2006-01	496 (8.1L) (G)	89017693	12574254	130-7260	—

				WATER PUMP	
YEAR	MODEL	O.E. NO.	O.E. CASTING	STANDARD	PERFORMANCE
CHEVROLET LIGHT DUTY TRUCKS: Suburban R20 / R2500 - 3/4 Ton 2WD					
V-8 Engine					
2006-04	323 (5.3L) (T, Z)	89017439		130-7341	—
2006-04	364 (6.0L) (U)	89017439		130-7341	—
1994-92	379 (6.2L) (C, J)	88894044	23500372	130-1830	—
2005-01	400 (6.6L) (1, 2) Duramax Diesel	97216136		130-5980	—
2006-01	496 (8.1L) (G)	89017693	12574254	130-7260	—
CHEVROLET LIGHT DUTY TRUCKS: Suburban V10 / V1500 - 1/2 Ton 4WD					
V-8 Engine					
2006-04	323 (5.3L) (T, Z)	89017439		130-7341	—
2006-04	364 (6.0L) (U)	89017439		130-7341	—
1994-92	379 (6.2L) (C, J)	88894044	23500372	130-1830	—
2005-01	400 (6.6L) (1, 2) Duramax Diesel	97216136		130-5980	—
2006-01	496 (8.1L) (G)	89017693	12574254	130-7260	—
CHEVROLET LIGHT DUTY TRUCKS: Suburban V20 / V2500 - 3/4 Ton 4WD					
V-8 Engine					
2006-04	323 (5.3L) (T, Z)	89017439		130-7341	—
2006-04	364 (6.0L) (U)	89017439		130-7341	—
1994-92	379 (6.2L) (C, J)	88894044	23500372	130-1830	—
2005-01	400 (6.6L) (1, 2) Duramax Diesel	97216136		130-5980	—
2006-01	496 (8.1L) (G)	89017693	12574254	130-7260	—
CHEVROLET LIGHT DUTY TRUCKS: Tahoe					
V-8 Engine					
2006-04	294 (4.8L) (V)	89017439		130-7341	—
2006-04	323 (5.3L) (T, Z)	89017439		130-7341	—
CHEVROLET LIGHT DUTY TRUCKS: TrailBlazer					
L-6 Engine					
2006-02	256 (4.2L) (S)	24576952		130-7700	—
V-8 Engine					
2006	364 (6.0L) (U) TrailBlazer SS	89017439		130-7341	—
2006-04	323 (5.3L) (M, P)	89017439		130-7341	—
CHEVROLET LIGHT DUTY TRUCKS: Venture Van					
V-6 Engine					
2005-97	207 (3.4L) (E)	12371989	14092225	130-1480	—
CHEVROLET TRUCK Medium & Heavy Duty: Series 40					
V-8 Engine					
2006-03	496 (8.1L) (E) Kodiak C4500	89017694 88893907	12558870	130-7090	—
CHEVROLET TRUCK Medium & Heavy Duty: Series 50					
V-8 Engine					
2006-03	496 (8.1L) (E) Kodiak C5500	89017694 88893907	12558870	130-7090	—
CHEVROLET TRUCK Medium & Heavy Duty: Series 60					
V-8 Engine					
2006-03	496 (8.1L) (E) Kodiak C6500	89017694 88893907	12558870	130-7090	—
CHEVROLET TRUCK Medium & Heavy Duty: Series 70					
V-8 Engine					
2006-03	496 (8.1L) (E) Kodiak C7500	89017694 88893907	12558870	130-7090	—
CHEVROLET TRUCK Medium & Heavy Duty: Series 80					
V-8 Engine					
2006-03	496 (8.1L) (E) Kodiak C8500	89017694 88893907	12558870	130-7090	—

				WATER PUMP	
YEAR	MODEL	O.E. NO.	O.E. CASTING	STANDARD	PERFORMANCE
CHRYSLER: Crossfire					
V-6 Engine					
2005-97	195 (3.2L)	12371989	14092225	130-1480	—
CHRYSLER: PT Cruiser					
4 Cylinder					
2006-03	148 (2.4L) Turbo	4884159AA	0488416AA	120-4360	—
2006-03	148 (2.4L) w/o Turbo	4694307AE	4694309AC	120-4220	—
CHRYSLER: Sebring					
4 Cylinder					
2006-01	148 (2.4L) (J, X) 4 Door Sedan	4694307AE	4694309AC	120-4220	—
V-6 Engine					
2006-01	167 (2.7L) 4 Door Sedan	4663732	4663736	120-4190	—
2005-03	181 (3.0L) Convertible and Coupe	MD978743		148-2320	—
CHRYSLER LIGHT DUTY TRUCKS: Town and Country Van					
V-6 Engine					
2005-01	201 (3.3L) (R)	4781157AA	04781159AA	120-4230	—
2005-01	230 (3.8L) (L)	4781157AA	04781159AA	120-4230	—
CUMMINS DIESEL: N14					
	N14-310, 330, 350, 370, 410 Idler Assembly	3066330		196-2045	—
DODGE: Neon (Inc. Neon SRT-4)					
4 Cylinder					
2005-95	122 (2.0L)	4667660AE	4667662	120-1300	—
2005-03	148 (2.4L) Turbo	4884159AA		120-4360	—
DODGE: Stratus					
4 Cylinder					
2006-97	148 (2.4L) DOHC 4 Door	4694307AB	4694309	120-4220	—
2005-01	143 (2.4L) (G) SOHC 2 Door	MD976943		148-2330	—
V-6 Engine					
2006-01	167 (2.7L) 4 Door Sedan	4663732	4663736	120-4190	—
2005-03	181 (3.0L) Coupe	MD978743		148-2320	—
DODGE LIGHT DUTY TRUCKS: Caravan, Grand Caravan					
4 Cylinder					
2006-97	148 (2.4L) (B)	4694307AB	4694309	120-4220	—
V-6 Engine					
2005-01	201 (3.3L) (R)	4781157AA	04781159AA	120-4230	—
2005-01	230 (3.8L) (L)	4781157AA	04781159AA	120-4230	—
DODGE LIGHT DUTY TRUCKS: Dakota					
V-6 Engine					
2005-04	226 (3.7L) (K)	53021187AA	53021185AA	120-4350	—
V-8 Engine					
2005-00	285 (4.7L) (J, K)	53021187AA	53021185AA	120-4350	—
DODGE LIGHT DUTY TRUCKS: Durango					
V-6 Engine					
2005-04	226 (3.7L) (K)	53021187AA	53021185AA	120-4350	—
V-8 Engine					
2005-00	285 (4.7L) (J, K, N)	53020873AB	53020871C	120-4350	—
2005-04	345 (5.7L)	53021380AK	53021378AB	120-4370	—
DODGE LIGHT DUTY TRUCKS: Pickup - Ram 1500-3500 (1/2, 3/4, 1 Ton)					
L-6 Engine					
2006-94	359 (5.9L) Diesel Cummins Turbo Diesel	5086959AA	2338-10C	120-3072	—

				WATER PUMP	
YEAR	MODEL	O.E. NO.	O.E. CASTING	STANDARD	PERFORMANCE
DODGE LIGHT DUTY TRUCKS: Pickup - Ram 1500-3500 (1/2, 3/4, 1 Ton) (Cont.)					
V-6 Engine					
2005-02	226 (3.7L) (K)	53021187AA	53021185AA	120-4350	—
V-8 Engine					
2006-03	345 (5.7L)	53021380AK	53021378AB	120-4370	—
2005-02	287 (4.7L) (N)	53021187AA	53021185AA	120-4350	—
FORD: LTD Crown Victoria					
V-8 Engine					
2005-99	281 (4.6L) (W,9) w/ Short Housing, Hub Height 2.578"	YW7Z-8501BB	YW7E-8501BB	125-5970	—
FORD: Focus					
4 Cylinder					
2005-04	140 (2.3L) (D)	YS4Z-8501AK		125-6000	—
2005-04	1989 (2.0) DOHC Fr. 4/5/2004	4S4Z-8501AA		125-6000	—
FORD: Mustang					
V-8 Engine					
2005	281 (4.6L)	YR3Z-8501AB	YR3E-8501AB	125-5950	—
FORD: Taurus					
V-6 Engine					
2005-04	183 (3.0L) (S) DOHC 24 Valve	2S7Z-8501BG	2S7E-8508AA	125-6060	—
2005-96	183 (3.0L) (1,2) Flex Fuel	F8DZ-8501AA XF1Z-8501AA 1F1Z-8501AA	RFF58E-8505AC	125-1820	125-1820P
2005-96	183 (3.0L) (U) Gas OHV 12 Valve	F8DZ-8501AA XF1Z-8501AA 1F1Z-8501AA	RFF58E-8505AC	125-1820	125-1820P
2003	183 (3.0L) (S) DOHC 24 Valve Fr. 4/1/2003	2S7Z-8501BG	2S7E-8508AA	125-6060	—
2003	183 (3.0L) (S) DOHC 24 Valve To 4/1/2003	XS2Z-8501EA	F53E-8508AB	125-1910	—
2002-01	183 (3.0L) (S) DOHC 24 Valve	XS2Z-8501CC	F53E-8508AB	125-1910	—
FORD: Thunderbird					
V-8 Engine					
2005-02	242 (3.9L) (A)	1W9Z-8501AA	1W93-8501	125-6030	—
FORD LIGHT DUTY TRUCKS: Freestar					
V-6 Engine					
2005-04	242 (3.9L) (6)	3F2Z-8501BB	RFF78E-8505BA	125-1970	—
2005-04	256 (4.2L) (2)	3F2Z-8501BB	RFF78E-8505BA	125-1970	—
FORD LIGHT DUTY TRUCKS: Escape					
4 Cylinder					
2005	140 (2.3L) Inc. Escape Hybrid	1S7Z-8501AK		125-6000	—
V-6 Engine					
2005-03	182 (3.0L) (1) Fr. 4/1/2003	2S7Z-8501BG	2S7E-8508AA	125-6060	—
2003-01	182 (3.0L) (1) To 4/1/2003	XS2Z-8501CC	F53E-8508AB	125-1910	—
FORD LIGHT DUTY TRUCKS: Excursion					
V-6 Engine					
2005-03	330 (5.4L) (L)	3L3Z-8501CA		125-6050	—
V-10 Engine					
2005-00	415 (6.8L) (S)	YC3Z-8501AA	F7TZ-AA	125-5920	—
FORD LIGHT DUTY TRUCKS: Expedition					
V-8 Engine					
2005-03	330 (5.4L) (L)	3L3Z-8501CA		125-6050	—
FORD LIGHT DUTY TRUCKS: Explorer					
V-6 Engine					
2005-97	244 (4.0L) (E, K) SOHC	F77Z-8501AD	97JM-8505A	125-2102	—

				WATER PUMP	
YEAR	MODEL	O.E. NO.	O.E. CASTING	STANDARD	PERFORMANCE
FORD LIGHT DUTY TRUCKS: Explorer (Cont.)					
V-8 Engine					
2005-02	281 (4.6L) (W)	1L2Z-8501BB	1L2E-8501BB	125-5990	—
FORD LIGHT DUTY TRUCKS: Ranger					
4 Cylinder					
2005-01	140 (2.3L) (D)	1S7Z-8501AK		125-6000	—
V-6 Engine					
2005-95	183 (3.0L) (U, V)	XL5Z-8501AA	RFF57E-8505CC	125-1850	125-1850P
2005-01	244 (4.0L) (E) SOHC	F77Z-8501AD	97JM-8505A	125-2102	—
FORD LIGHT DUTY TRUCKS: Van E150 - 1/2 Ton					
V-8 Engine					
2005-04	281 (4.6L) (W)	3L3Z-8501CA		125-6050	—
2005-03	330 (5.4L)	3L3Z-8501CA		125-6050	—
FORD LIGHT DUTY TRUCKS: Van E250 - 3/4 Ton					
V-8 Engine					
2005-04	281 (4.6L) (W)	3L3Z-8501CA		125-6050	—
1998-97	281 (4.6L) (6)	F7UZ-8501CA	F7UE-8505AA	125-1980	—
2005-03	330 (5.4L)	3L3Z-8501CA		125-6050	—
1995-94	446 (7.3L) (F) w/ bleeder tubing	F5TZ-8501BRM	1822823-C1	125-5721	—
FORD LIGHT DUTY TRUCKS: Van E350 - 1 Ton					
V-8 Engine					
2005-03	330 (5.4L)	3L3Z-8501CA		125-6050	—
1995-94	446 (7.3L) (F) w/ bleeder tubing	F5TZ-8501BRM	1822823-C1	125-5721	—
V-10 Engine					
2005-97	415 (6.8L) (S)	YC3Z-8501AA F81Z-8501DA	F7TZ-AA F7TE-AA	125-5920	—
FORD LIGHT DUTY TRUCKS: Van E450					
V-8 Engine					
2005-03	330 (5.4L)	3L3Z-8501CA		125-6050	—
V-10 Engine					
2005-01	415 (6.8L) (S)	YC3Z-8501AA F81Z-8501DA	F7TZ-AA F7TE-AA	125-5920	—
FORD LIGHT DUTY TRUCKS: Van E Super Duty					
V-10 Engine					
2005-97	415 (6.8L) (S)	YC3Z-8501AA F81Z-8501DA	F7TZ-AA F7TE-AA	125-5920	—
FORD LIGHT DUTY TRUCKS: F59 Stripped Chassis					
V-8 Engine					
1996-95	446 (7.3L) (F) w/ bleeder tubing	F5TZ-8501BRM	1822823-C1	125-5721	—
FORD LIGHT DUTY TRUCKS: Pickup F150 1/2 Ton					
L-6 Engine					
1992	300 (4.9L) (Y) 5.4 in. Hub Ht.	F0TZ-8501F	F0TE-8505BA	125-1620	—
1992	300 (4.9L) (Y) 5.0 in. Hub Ht.	F2UZ-8501A	F0TE-8505BA	125-1760	—
V-6 Engine					
2005-97	256 (4.2L) (2)	F65Z-8501AC	RFF65E-8505AE	125-2101	—
V-8 Engine					
2005-03	281 (4.6L) (W)	3L3Z-8501CA		125-6050	—
2005-03	330 (5.4L) (L)	3L3Z-8501CA		125-6050	—
FORD LIGHT DUTY TRUCKS: Pickup F250 3/4 Ton					
V-8 Engine					
2005-03	281 (4.6L) (W)	3L3Z-8501CA		125-6050	—
2005-03	330 (5.4L) (L)	3L3Z-8501CA		125-6050	—
1995-94	446 (7.3L) (F) w/ bleeder tubing	F5TZ-8501BRM	1822823-C1	125-5721	—

				WATER PUMP	
YEAR	MODEL	O.E. NO.	O.E. CASTING	STANDARD	PERFORMANCE
FORD LIGHT DUTY TRUCKS: Pickup F350 1 Ton					
V-8 Engine					
1995-94	446 (7.3L) (F) w/ bleeder tubing	F5TZ-8501BRM	1822823-C1	125-5721	—
FORD LIGHT DUTY TRUCKS: Pickup F250 Super Duty 3/4 Ton					
V-8 Engine					
2005-03	330 (5.4L) (L)	3L3Z-8501CA		125-6050	—
V-10 Engine					
2005-99	415 (6.8L) (S)	YC3Z-8501AA	F7TZ-AA	125-5920	—
FORD LIGHT DUTY TRUCKS: Pickup F350 Super Duty 1 Ton					
V-8 Engine					
2005-03	330 (5.4L) (L)	3L3Z-8501CA		125-6050	—
1995-94	446 (7.3L) (F) w/ bleeder tubing	F5TZ-8501BRM	1822823-C1	125-5721	—
V-10 Engine					
2005-99	415 (6.8L) (S)	YC3Z-8501AA	F7TZ-AA	125-5920	—
FORD LIGHT DUTY TRUCKS: Pickup F450 Super Duty					
V-10 Engine					
2005-99	415 (6.8L) (S)	YC3Z-8501AA	F7TZ-AA	125-5920	—
FORD LIGHT DUTY TRUCKS: Pickup F550 Super Duty					
V-10 Engine					
2005-99	415 (6.8L) (S)	YC3Z-8501AA	F7TZ-AA	125-5920	—
FORD LIGHT DUTY TRUCKS: Windstar					
V-6 Engine					
2003-96	232 (3.8L) (4)	F68Z-8501A	RFF68E-8505BC	125-1970	—
1995	232 (3.8L) (4)	F4DZ-8501A	RFF4DE-8505AB	125-1790	—
GMC LIGHT DUTY TRUCKS: Canyon					
4 Cylinder					
2006-04	169 (2.8L) (8)	24576952		130-7700	—
L-5 Engine					
2006-04	211 (3.5L) (6)	24576952		130-7700	—
GMC LIGHT DUTY TRUCKS: Envoy (Inc. Envoy XL, Denali)					
L-6 Engine					
2006-02	256 (4.2L) (S)	24576952		130-7700	—
V-8 Engine					
2006-03	323 (5.3L) (P)	89017439		130-7341	—
GMC LIGHT DUTY TRUCKS: Van G35/3500 - 1 Ton					
V-8 Engine					
1998-97	395 (6.5L) (F) Diesel	12534772	12557071	130-7200	—
GMC LIGHT DUTY TRUCKS: Van Savana G1500 - 1/2 Ton					
V-6 Engine					
2006-96	262 (4.3L) (W, X)	12532528		130-1820	130-1820P
V-8 Engine					
2006-04	323 (5.3L) (T) w/ 4spd. Auto Trans.	89017439		130-7341	—
GMC LIGHT DUTY TRUCKS: Van Savana G2500 - 3/4 Ton					
V-6 Engine					
2006-96	262 (4.3L) (W, X)	12532528		130-1820	130-1820P
V-8 Engine					
2006-04	294 (4.8L) (V)	89017439		130-7341	—
2006-04	323 (5.3L) (T) w/ 4spd. Auto Trans.	89017439		130-7341	—
2006-04	364 (6.0L) (U)	89017439		130-7341	—

				WATER PUMP	
YEAR	MODEL	O.E. NO.	O.E. CASTING	STANDARD	PERFORMANCE
GMC LIGHT DUTY TRUCKS: Van Savana G3500 - 1 Ton					
V-8 Engine					
2006-04	364 (6.0L) (U)	89017439		130-7341	—
GMC LIGHT DUTY TRUCKS: Safari Van					
V-6 Engine					
2005-98	262 (4.3L) (W, X)	12532528	10238199	130-1820	130-1820P
GMC LIGHT DUTY TRUCKS: Pickup Sierra 2WD - 1 Ton (Inc. HD)					
V-8 Engine					
2006-04	364 (6.0L) (U)	89017439		130-7341	—
2005-01	400 (6.6L) Duramax Diesel	97216136		130-5980	—
2006-01	496 (8.1L) (G)	88893906	12558869	130-7260	—
GMC LIGHT DUTY TRUCKS: Pickup Sierra 2WD - 1/2 Ton (Inc. HD)					
V-6 Engine					
2006-99	262 (4.3L) (W, X)	12532528	10238199	130-1820	130-1820P
V-8 Engine					
2006-04	323 (5.3L) (T, Z)	89017439		130-7341	—
2006-04	294 (4.8L) (V)	89017439		130-7341	—
2006-04	364 (6.0L) (N, V)	89017439		130-7341	—
2006-01	496 (8.1L) (G)	88893906	12558869	130-7260	—
GMC LIGHT DUTY TRUCKS: Pickup Sierra 2WD - 3/4 Ton (Inc. HD)					
V-8 Engine					
2006-04	323 (5.3L) (T, Z)	89017439		130-7341	—
2006-04	364 (6.0L) (U)	89017439		130-7341	—
2005-01	400 (6.6L) Duramax Diesel	97216136		130-5980	—
2006-01	496 (8.1L) (G)	88893906	12558869	130-7260	—
GMC LIGHT DUTY TRUCKS: Pickup Sierra 4WD - 1 Ton (Inc. HD)					
V-8 Engine					
2006-04	364 (6.0L) (U)	89017439		130-7341	—
2005-01	400 (6.6L) Duramax Diesel	97216136		130-5980	—
2006-01	496 (8.1L) (G)	88893906	12558869	130-7260	—
GMC LIGHT DUTY TRUCKS: Pickup Sierra 4WD - 1/2 Ton (Inc. HD)					
V-6 Engine					
2006-99	262 (4.3L) (W, X)	12532528	10238199	130-1820	130-1820P
V-8 Engine					
2006-04	323 (5.3L) (T, Z)	89017439		130-7341	—
2006-04	294 (4.8L) (V)	89017439		130-7341	—
2006-04	364 (6.0L) (N, V)	89017439		130-7341	—
2006-01	496 (8.1L) (G)	88893906	12558869	130-7260	—
GMC LIGHT DUTY TRUCKS: Pickup Sierra 4WD - 3/4 Ton (Inc. HD)					
V-8 Engine					
2006-04	323 (5.3L) (T, Z)	89017439		130-7341	—
2006-04	364 (6.0L) (U)	89017439		130-7341	—
2005-01	400 (6.6L) Duramax Diesel	97216136		130-5980	—
2006-01	496 (8.1L) (G)	88893906	12558869	130-7260	—
GMC LIGHT DUTY TRUCKS: Yukon XL 1500					
V-8 Engine					
2006-04	323 (5.3L) (T, Z)	89017439		130-7341	—
2006-04	364 (6.0L) (U)	89017439		130-7341	—
2003-00	364 (6.0L) (U)	12458935	12562458	130-7340	—
2006-01	496 (8.1L) (G)	88893906	12558869	130-7260	—
GMC LIGHT DUTY TRUCKS: Yukon XL 2500					
V-8 Engine					
2006-04	323 (5.3L) (T, Z)	89017439		130-7341	—
2006-04	364 (6.0L) (U)	89017439		130-7341	—
2006-01	496 (8.1L) (G)	88893906	12558869	130-7260	—

				WATER PUMP	
YEAR	MODEL	O.E. NO.	O.E. CASTING	STANDARD	PERFORMANCE
GMC LIGHT DUTY TRUCKS: Yukon					
V-8 Engine					
2006-04	294 (4.8L) (V)	89017439		130-7341	—
2006-04	323 (5.3L) (T, Z)	89017439		130-7341	—
2003-00	323 (5.3L) (T)	12458935	12562458	130-7340	—
2006-04	364 (6.0L) (U) Inc. Denali, Denali XL	89017439		130-7341	—
2006-01	496 (8.1L) (G)	88893906	12558869	130-7260	—
GMC TRUCK Medium & Heavy Duty: Series 40-90					
V-8 Engine					
2006-03	496 (8.1L) (E) Topkick C4500/5500/6500/7500/8500	89017694 88893907	12558870	130-7090	—
GMC TRUCK Medium & Heavy Duty: C6 Series					
V-8 Engine					
2006-03	496 (8.1L) (E) Topkick	89017694 88893907	12558870	130-7090	—
GMC TRUCK Medium & Heavy Duty: C7 Series					
V-8 Engine					
2006-03	496 (8.1L) (E) Topkick	89017694 88893907	12558870	130-7090	—
HONDA: Accord					
4 Cylinder					
2004-03	2354 (2.4L) DX, EX, LX	19200-RAA-A01		135-1500	—
V-6 Engine					
2004-03	2977 (3.0L) EX, LX	19200-RCA-A01 19200-RDM-A01		135-1530	—
HONDA: Civic Del Sol					
4 Cylinder					
1995-94	1590 (1.6L) B16A VTEC, DOHC	19200-P30-003		135-2200	—
HONDA: Civic, CVCC					
4 Cylinder					
1995-92	1590 (1.6L) D16Z EX, SI w/ VTEC	19200-P08-004		135-1320	—
2005-01	1668 (1.7L) D17A 1/2/6/7	19200-PLM-A01		135-2420	—
2005-02	1998 (2.0L)	19200-PNA-003		135-1520	—
HONDA: Element					
4 Cylinder					
2004-03	2351 (2.4L)	19200-RAA-A01		135-1500	—
HONDA LIGHT DUTY TRUCKS: CR-V					
4 Cylinder					
2004-02	2400 (2.4L) EX, LX	19200-PNA-003		135-1520	—
HUMMER: H2 Series					
V-8 Engine					
2006-04	364 (6.0L) (U)	89017439		130-7341	—
HYUNDAI: Accent					
4 Cylinder					
2005-01	1600 (1.6L)	25100-26901		146-2070	—
1999-95	1495 (1.5L) DOHC	25100-26901		146-1230	—
1999-95	1495 (1.5L) SOHC	25100-26015 25100-22010		148-1170	—
HYUNDAI: Elantra					
4 Cylinder					
2005-99	1975 (2.0L)	25100-23010 25100-23002		146-2020	—

				WATER PUMP	
YEAR	MODEL	O.E. NO.	O.E. CASTING	STANDARD	PERFORMANCE
HYUNDAI: Sonata					
4 Cylinder					
2005-99	2351 (2.4L)	25100-38200 25100-38002		146-1110	—
INFINITI: G35					
V-6 Engine					
2005-03	3500 (3.5L) VQ35DE	21010-AL525 21010-AL526		150-2320	—
ISUZU LIGHT DUTY TRUCKS: Ascender					
L-6 Engine					
2005-03	256 (4.2L)	8-24576-952-0		130-7700	—
V-8 Engine					
2005-03	323 (5.3L)	8-89017-439-0	12569519	130-7340	—
JAGUAR: S Type					
V-6 Engine					
2003	2967 (3.0L)	AJ84817		125-6040	—
V-8 Engine					
2002-00	3996 (4.0L)	JLM20915		125-6030	—
JAGUAR: XJ-6, XJ-6L					
L-6 Engine					
1994	3980 (4.0L)	EBC10967	EBC10564	113-2120	—
V-8 Engine					
2003-97	3996 (4.0L)	JLM20915		125-6030	—
JAGUAR: XJR					
L-6 Engine					
1997-95	3980 (4.0L)	EBC10967	EBC10564	113-2120	—
JAGUAR: XJS					
L-6 Engine					
1996-95	3980 (4.0L)	EBC10967	EBC10564	113-2120	—
JEEP: Grand Cherokee					
V-6 Engine					
2006-05	226 (3.7L) (K)	53021187AA 53020873AC		120-4350	—
V-8 Engine					
2006-99	285 (4.7L)	53021187AA 53020873AC		120-4350	—
JEEP: Liberty					
V-6 Engine					
2006-02	226 (3.7L) (K)	53021187AA 53020873AC		120-4350	—
JEEP: Wrangler					
4 Cylinder					
2006-03	148 (2.4L) (1)	4694307AB 4694307AC	4694309	120-4220	—
L-6 Engine					
2006-00	242 (4.0L) (S)	05012366AD	53010417	120-4340	—
KIA: Optima					
4 Cylinder					
2005-01	2351 (2.4L)	25100-38002 25100-38200	HY-11-11-2	146-1110	—

				WATER PUMP	
YEAR	MODEL	O.E. NO.	O.E. CASTING	STANDARD	PERFORMANCE
KIA: Spectra					
4 Cylinder					
2004-00	1793 (1.8L)	0247-15-010B OK247-15-010B		143-2001	—
KIA LIGHT DUTY TRUCKS: Sportage					
4 Cylinder					
2005	1975 (2.0L)	25100-23021		146-2020	—
LEXUS: GS430					
V-8 Engine					
2005-01	4300 (4.3L) 3UZ-FE	16100-59275		170-1840	—
LEXUS: GS470					
V-8 Engine					
2005-03	4663 (4.7L) 2UZ-FE	16100-59275		170-1840	—
LEXUS: IS300					
L-6 Engine					
2005-01	2997 (3.0L) 2JZ-GE	16110-49156		170-2380	—
LEXUS: LS430					
V-8 Engine					
2005-01	4293 (4.3L) 3UZ-FE Behind Idler	16100-59275		170-1840	—
LEXUS: LX470					
V-8 Engine					
2005-98	4663 (4.7L) 2UZ-FE	16100-59275		170-1840	—
LEXUS: RX330					
V-6 Engine					
2005-04	3300 (3.3L) 3MZ-FE Eng. # starts with 0	16100-29085		170-1920	—
LEXUS: RX400H					
V-6 Engine					
2006	3311 (3.3L)	16100-29085		170-1920	—
LEXUS: SC430					
V-8 Engine					
2005-02	4300 (4.3L)	16100-59275		170-1840	—
LINCOLN: Aviator					
V-8 Engine					
2005-03	281 (4.6L)	3L3Z-8501CA		125-6050	—
LINCOLN: LS					
V-6 Engine					
2005-03	181 (3.0L) (S)	2R8Z-8501AE	2R8E-8505AB	125-6040	—
V-8 Engine					
2005-00	242 (3.9L) (A)	XW4Z-8501AA	XW43-8501	125-6030	—
LINCOLN: Navigator					
V-8 Engine					
2005-02	330 (5.4L) (R)	YC2Z-8501BA	YC2E-8501BA	125-6050	—
LINCOLN: Town Car					
V-8 Engine					
2005	281 (4.6L) (W)	YW7Z-8501BB	YW7E-8501BB	125-5970	—

				WATER PUMP	
YEAR	MODEL	O.E. NO.	O.E. CASTING	STANDARD	PERFORMANCE
MAZDA: 3					
4 Cylinder					
2005-04	2000 (2.0L)	LF01-15-100		125-6000	—
2005-04	2254 (2.3L)	LF01-15-100		125-6000	—
MAZDA: 6					
4 Cylinder					
2005-03	2254 (2.3L)	LF01-15-100		125-6000	—
MAZDA: Miata, MX5					
4 Cylinder					
2005-99	1839 (1.8L)	8ABB-15-010A		145-1390	—
MAZDA LIGHT DUTY TRUCKS: B3000 Pickup					
V-6 Engine					
2005-95	2954 (3.0L)	ZZR1-15-010 ZMZ7-15-010	RFF57E-8505CC	125-1850	125-1850P
MAZDA LIGHT DUTY TRUCKS: B4000 Pickup					
V-6 Engine					
2005-01	4016 (4.0L)	1F22-15-010	97JM-8505AD	125-2102	—
MAZDA LIGHT DUTY TRUCKS: MPV					
V-6 Engine					
2005-04	2967 (3.0L)	AJ03-15-010G	2S7E-8508AA	125-6060	—
MAZDA LIGHT DUTY TRUCKS: Tribute					
4 Cylinder					
2005	2261 (2.3L)	LF52-15-100		125-6000	—
V-6 Engine					
2005-01	2967 (3.0L)	AJ03-15-010G	2S7E-8508AA	125-6060	—
MERCEDES BENZ: C Series					
V-6 Engine					
2005-01	2597 (2.6L) C240 2 Hose Connections	112-200-1501	A112-201-0601	147-2250	—
2005-98	3199 (3.2L) C320 2 Hose Connections	112-200-1501	A112-201-0601	147-2250	—
V-8 Engine					
2005	5439 (5.5L) C55 3 Hose Connections	112-200-1401	112-201-0501	147-2220	—
MERCEDES BENZ: CL Series					
V-8 Engine					
2005-00	4966 (5.0L) CL500 2 Hose Connections	112-200-1501	A112-201-0601	147-2250	—
MERCEDES BENZ: CLK Series					
V-6 Engine					
2005-98	3199 (3.2L) CLK320 2 Hose Connections	112-200-1501	A112-201-0601	147-2250	—
V-8 Engine					
2005-03	5439 (5.5L) CLK500 2 Hose Connections	112-200-1501	A112-201-0601	147-2250	—
2005-01	5439 (5.5L) CLK55 3 Hose Connections	112-200-1401	112-201-0501	147-2220	—
MERCEDES BENZ: CLS Series					
V-8 Engine					
2006	4966 (5.0L) CLS500 2 Hose Connections	112-200-1501	A112-201-0601	147-2250	—
MERCEDES BENZ: E Series					
V-8 Engine					
2005-03	4966 (5.0L) E500 2 Hose Connections	112-200-1501	A112-201-0601	147-2250	—
MERCEDES BENZ: G Series					
V-8 Engine					
2005-02	4966 (5.0L) G500 2 Hose Connections	112-200-1501	A112-201-0601	147-2250	—
2005-03	5439 (5.5L) G55 Inc. AMG; 3 Hose Connections	112-200-1401	112-201-0501	147-2220	—

				WATER PUMP	
YEAR	MODEL	O.E. NO.	O.E. CASTING	STANDARD	PERFORMANCE
MERCEDES BENZ: ML Series					
V-6 Engine					
2005-03	3699 (3.7L) ML350 2 Hose Connections	112-200-1501	A112-201-0601	147-2250	—
V-8 Engine					
2006-02	4973 (5.0L) ML500 3 Hose Connections	112-200-1401	112-201-0501	147-2220	—
MERCEDES BENZ: S Series					
V-8 Engine					
2006-00	4266 (4.3L) S430 2 Hose Connections	112-200-1501	A112-201-0601	147-2250	—
2006-00	4966 (5.0L) S500 2 Hose Connections	112-200-1501	A112-201-0601	147-2250	—
MERCURY: Mariner					
4 Cylinder					
2005	140 (2.3L)	4S4Z-8501AA		125-6000	—
MERCURY: Grand Marquis					
V-8 Engine					
2005-03	281 (4.6L) (W) SOHC	YW7Z-8501BB	YW7E-8501BB	125-5970	—
2002-99	281 (4.6L) (W) w/ Police, 3.23" 7 vane impeller, Hub Height 3.423in.	YR3Z-8501AB	YR3E-8501AB	125-5950	—
MERCURY: Marauder					
V-8 Engine					
2004-03	281 (4.6L) (W) w/ Short Housing, Hub Height 2.578in	YW7Z-8501BB	YW7E-8501BB	125-5970	—
2004-03	281 (4.6L) (W) w/ Long Housing, Hub Height 3.423in. 8 vane impeller	YW7Z-8501AA		125-1830	—
MERCURY: Monterey					
V-6 Engine					
2005-04	256 (4.2L) (2)	3F2Z-8501BB	RFF78E-8505BA	125-1970	—
MERCURY: Sable					
V-6 Engine					
2005-04	182 (3.0L) (S) DOHC, 24 Valve From 4/1/04	2S7Z-8501BG	2S7E-8508AA	125-6060	—
2004-01	182 (3.0L) (S) DOHC, 24 Valve To 4/1/04	XS2Z-8501CC	F53E-8508AB	125-1910	—
2005-96	182 (3.0L) (U) OHV, 12 Valve	1F1Z-8501AA F8DZ-8501AA F6DZ-8501FA	RFF58E-8505AC	125-1820	125-1820P
MERCURY LIGHT DUTY TRUCKS: Mountaineer					
V-6 Engine					
2005-98	245 (4.0L) (E, K)	F77Z-8501AD	97JM-8505A	125-2102	—
V-8 Engine					
2005-02	281 (4.6L) (W)	1L2Z-8501BB	1L2E-8501BB	125-5990	—
MITSUBISHI: Endeavor					
V-6 Engine					
2005-04	3828 (3.8L)	MD978743		148-2320	—
MITSUBISHI: Galant					
4 Cylinder					
2004	2351 (2.4L)	MD979395		148-1780	—
2003-99	2351 (2.4L)	MD976943 MD976464		148-2330	—
V-6 Engine					
2005-00	3828 (3.8L)	MD978743		148-2320	—
MITSUBISHI: Lancer					
4 Cylinder					
2005-02	2000 (2.0L)	MD309756		148-2280	—
2004-03	2000 (2.0L) Evolution	MD979313		148-1780	—
2004	2400 (2.4L) Sportback	MD979395		148-1780	—

				WATER PUMP	
YEAR	MODEL	O.E. NO.	O.E. CASTING	STANDARD	PERFORMANCE
MITSUBISHI LIGHT DUTY TRUCKS: Montero					
V-6 Engine					
2002-01	3497 (3.5L) 6G74 Engine Vin R	MD977503		148-1790	—
2004-03	3797 (3.8L)	MD979171		148-1790	—
MITSUBISHI LIGHT DUTY TRUCKS: Outlander					
4 Cylinder					
2004	2351 (2.4L)	MD979395		148-1780	—
2003	2351 (2.4L)	MD978552		148-1810	—
NISSAN: 350Z					
V-6 Engine					
2005-03	3498 (3.5L) VQ35DE	21010-AL526 21010-AL527		150-2320	—
NISSAN: Altima					
V-6 Engine					
2005-02	3498 (3.5L) VQ35DE	21010-AL526 21010-AL527		150-2320	—
NISSAN: Maxima					
V-6 Engine					
2005-02	3498 (3.5L) VQ35DE	21010-AL526 21010-AL527		150-2320	—
NISSAN: Sentra					
4 Cylinder					
2005-02	2488 (2.5L) QR25DE	21010-8J000		150-2340	—
NISSAN LIGHT DUTY TRUCKS: Frontier Pickup					
V-6 Engine					
2005	3954 (4.0L)	21010-AL526 21010-7Y025		150-2320	—
NISSAN LIGHT DUTY TRUCKS: Murano					
V-6 Engine					
2005-03	3498 (3.5L) VQ35DE	21010-AL526 21010-7Y025		150-2320	—
NISSAN LIGHT DUTY TRUCKS: Pathfinder					
V-6 Engine					
2005	3954 (4.0L)	21010-AL526 21010-7Y025		150-2320	—
NISSAN LIGHT DUTY TRUCKS: Xterra					
V-6 Engine					
2005	3954 (4.0L)	21010-AL526 21010-7Y025		150-2320	—
PONTIAC: Bonneville					
V-6 Engine					
2005-96	230 (3.8L) (K, 1)	12482903 12537829	12564115 24504920	130-1780	—
V-8 Engine					
2005-04	281 (4.6L) (Y)	89017467 88894344		130-1840	—
PONTIAC: GTO					
V-8 Engine					
2005	364 (6.0L) (U)	89017593		130-7290	—

				WATER PUMP	
YEAR	MODEL	O.E. NO.	O.E. CASTING	STANDARD	PERFORMANCE
PONTIAC: Grand Am					
4 Cylinder					
2005-02	134 (2.2L) (F)	24467301 24439798	12586485 12583467	130-7350	—
PONTIAC: Grand Prix					
V-6 Engine					
2005-97	230 (3.8L) (1,2,4,K)	12482903 12537829	12564115 24504920	130-1780	—
PONTIAC: Sunfire					
4 Cylinder					
2005-02	134 (2.2L) (F)	24467301 24439798	12586485 12583467	130-7350	—
PONTIAC: Vibe					
4 Cylinder					
2006-03	1762 (1.8L) (L) GT	88972819		170-2400	—
2006-03	1762 (1.8L) (8) Inc.AWD	88972167		130-7360	—
SATURN: ION					
4 Cylinder					
2005-03	122 (2.0L) Red Line	24467301 24439798	12586485 12583467	130-7350	—
2005-03	134 (2.2L)	24467301 24439798	12586485 12583467	130-7350	—
SATURN: SC Series (SC Coupe, SC1, SC2)					
4 Cylinder					
2002-95	116 (1.9L) (7, 8)	21015340 21007655		130-1800	—
SATURN: SL Series (SL Sedan, SL1, SL2)					
4 Cylinder					
2002-95	116 (1.9L) (7, 8)	21015340 21007655		130-1800	—
SATURN: SW Series (SW Wagon, SW1, SW2)					
4 Cylinder					
2002-95	116 (1.9L) (7, 8)	21015340 21007655		130-1800	—
SATURN: Vue					
4 Cylinder					
2005-02	134 (2.2L)	24467301 24439798	12586485 12583467	130-7350	—
SCION: XA					
4 Cylinder					
2005-03	1497 (1.5L)	16100-29155		170-2101	—
SCION: XB					
4 Cylinder					
2005-03	1497 (1.5L)	16100-29155		170-2101	—
SUBARU: Baja					
4 Cylinder					
2005-03	2458 (2.5L) EJ253 w/o Turbo	21111-AA110		160-1120	—
SUBARU: Forester					
4 Cylinder					
2005-99	2457 (2.5L) w/ MT, X Model	21111-AA110		160-1120	—

				WATER PUMP	
YEAR	MODEL	O.E. NO.	O.E. CASTING	STANDARD	PERFORMANCE
SUBARU: Legacy					
4 Cylinder					
2005-97	2457 (2.5L) EJ253	21111-AA110		160-1120	—
SUBARU: Outback					
4 Cylinder					
2005-98	2457 (2.5L) EJ253	21111-AA110		160-1120	—
6 Cylinder					
2005-01	2999 (3.0L) EZ30D	21110-AA360		160-2070	—
SUZUKI: Aerio					
4 Cylinder					
2005-04	2300 (2.3L)	17400-77810		165-2001	—
SUZUKI LIGHT DUTY TRUCKS: Grand Vitara					
V-6 Engine					
2005-99	2494 (2.5L)	17400-85830		165-1200	—
TOYOTA: Camry					
4 Cylinder					
2005-02	2398 (2.4L) 2AZFE	16100-0H010 16100-28040		170-2470	—
V-6 Engine					
2005-94	2995 (3.0L) 1MZFE	16100-29085		170-1920	—
2005-04	3300 (3.3L) 3MZFE	16100-29085		170-1920	—
TOYOTA: Carina, Corolla					
4 Cylinder					
2005-03	1762 (1.8L) 1ZZFE	16100-29175		130-7360	—
2005	1762 (1.8L) 2ZZGE	16100-29175		130-7360	—
TOYOTA: Celica					
4 Cylinder					
2005-02	1762 (1.8L) 1ZZFE	16100-29175		130-7360	—
2005-00	1762 (1.8L) 2ZZGE GTS	16100-29145		170-2400	—
1993-88	1998 (2.0L) 3SGTE AWD, Inc. Turbo	16110-79115		170-2107	—
1989-86	1998 (2.0L) 3SGELC GTS	16110-79095		170-1670	—
TOYOTA: Echo					
4 Cylinder					
2005-00	1497 (1.5L) 1NZFE	16100-29155		170-2101	—
TOYOTA: Matrix					
4 Cylinder					
2005-03	1762 (1.8L) XRS 2ZZGE	16100-29145		170-2400	—
2005-03	1762 (1.8L) 1ZZFE	16100-09170		130-7360	—
TOYOTA: MR2					
4 Cylinder					
1995-91	1998 (2.0L) 3SGTE Turbo	16110-79115		170-2107	—
TOYOTA: MR2 Spyder					
4 Cylinder					
2005-02	1762 (1.8L) 1ZZFE	16100-09170		130-7360	—
TOYOTA: Prius					
4 Cylinder					
2005-01	1497 (1.5L) 1NZFXE Electric/Gas	16100-29155		170-2101	—
TOYOTA: Solara					
4 Cylinder					
2005-02	2398 (2.4L) 2AZFE	16100-28040 16100-0H010		170-2470	—

				WATER PUMP	
YEAR	MODEL	O.E. NO.	O.E. CASTING	STANDARD	PERFORMANCE
TOYOTA: Solara (Cont.)					
V-6 Engine					
2005-04	3300 (3.3L) 3MZFE	16100-29085		170-1920	—
TOYOTA LIGHT DUTY TRUCKS: 4 Runner					
V-8 Engine					
2005-03	4663 (4.7L) 2UZFE	16100-59275		170-1840	—
TOYOTA LIGHT DUTY TRUCKS: Highlander					
4 Cylinder					
2005-01	2398 (2.4L) 2AZFE	16100-28040		170-2470	—
V-6 Engine					
2005-04	3300 (3.3L) 3MZFE	16100-29085		170-1920	—
TOYOTA LIGHT DUTY TRUCKS: Landcruiser					
V-8 Engine					
2005-98	4663 (4.7L) 2UZFE	16100-59275		170-1840	—
TOYOTA LIGHT DUTY TRUCKS: RAV 4					
4 Cylinder					
2005-04	2398 (2.4L) 2AZFE	16100-28040		170-2470	—
TOYOTA LIGHT DUTY TRUCKS: Sequoia					
V-8 Engine					
2005-01	4663 (4.7L) 2UZFE	16100-59275		170-1840	—
TOYOTA LIGHT DUTY TRUCKS: Sienna Van					
V-6 Engine					
2005-04	3300 (3.3L) 3MZFE	16100-29085		170-1920	—
TOYOTA LIGHT DUTY TRUCKS: Tacoma					
4 Cylinder					
2004	2438 (2.4L) 2RZFE	16100-79445		170-3310	—
2003-95	2438 (2.4L) 2RZFE w/o By-Pass Tube	16100-79225		170-1960	—
2004	2694 (2.7L) 3RZFE	16100-79445		170-3310	—
2003-95	2694 (2.7L) 3RZFE w/o By-Pass Tube	16100-79225		170-1960	—
V-6 Engine					
2004-03	3378 (3.4L) 5VZFE w/ By-Pass Tube	16100-69398		170-1970	—
2000-95	3378 (3.4L) 5VZFE 2WD w/ AT w/ Column Shift	16100-69405		170-2103	—
TOYOTA LIGHT DUTY TRUCKS: Tundra					
V-6 Engine					
2004	3378 (3.4L) 5MZFE w/ AT	16100-69398		170-1970	—
2004	3378 (3.4L) 5MZFE w/ MT	16100-69408		170-2103	—
2003-02	3378 (3.4L) 5MZFE 2WD w/ AT	16100-69405		170-2103	—
V-6 Engine					
2005-00	4663 (4.7L) 2UZFE	16100-59275		170-1840	—
VOLKSWAGEN: Beetle					
4 Cylinder					
2005-99	1781 (1.8L) Inc. Turbo	06A-121-011T	06A-121-031C	180-2220	—
2005-98	1896 (1.9L) Diesel Turbo	06A-121-011L	06A-121-019H	180-2200	—
		038-121-011A	038-121-019A		
2005-98	1984 (2.0L)	038-121-011G	038-121-019D	180-2220	—
		06A-121-011T	06A-121-031C		
		06A-121-011L	06A-121-019H		

				WATER PUMP	
YEAR	MODEL	O.E. NO.	O.E. CASTING	STANDARD	PERFORMANCE
VOLKSWAGEN: Golf, Golf GTI					
4 Cylinder					
2005-00	1780 (1.8L) Inc. Turbo Gas w/ Cogged Pulley	06A-121-011T 06A-121-011L	06A-121-031C 06A-121-019H	180-2220	—
2005-00	1896 (1.9L) Diesel Turbo w/ Cogged Pulley	038-121-011A 038-121-011G	038-121-019A 038-121-019D	180-2200	—
2005-99	1984 (2.0L) Gas w/ Cogged Pulley	06A-121-011T 06A-121-011L	06A-121-031C 06A-121-019H	180-2220	—
VOLKSWAGEN: Jetta, Jetta GLI					
4 Cylinder					
2005-00	1780 (1.8L) Inc. Turbo Gas w/ Cogged Pulley	06A-121-011T 06A-121-011L	06A-121-031C 06A-121-019H	180-2220	—
2005-99	1896 (1.9L) Diesel Turbo w/ Cogged Pulley	038-121-011A 038-121-011G	038-121-019A 038-121-019D	180-2200	—
2005-99	1984 (2.0L) Gas w/ Cogged Pulley	06A-121-011T 06A-121-011L	06A-121-031C 06A-121-019H	180-2220	—
VOLKSWAGEN: Passat, Passat Syncro					
4 Cylinder					
2005-00	1780 (1.8L) Inc. Turbo Gas w/ Cogged Pulley	06A-121-011T 06A-121-011L	06A-121-031C 06A-121-019H	180-2220	—
2005	1968 (2.0L) Turbo Diesel	038-121-011G	038-121-019D	180-2200	—
V-6 Engine					
2005-98	2771 (2.8L) Gas	078-121-006 078-121-004Q	078-121-019F	180-2120	—
VOLVO: C70					
5 Cylinder					
2004-98	2319 (2.3L) B5234FT	272476-3		190-2120	—
2004-98	2435 (2.4L) B5254FS/B52554T7 Inc. Turbo	272476-3		190-2120	—
VOLVO: S40					
4 Cylinder					
2004-00	1900 (1.9L)	272476-3		190-2120	—
VOLVO: S60					
5 Cylinder					
2004-01	2319 (2.3L) B5234FT Turbo	272476-3		190-2120	—
2004-01	2435 (2.4L) Inc. Turbo	272476-3		190-2120	—
2004-03	2500 (2.5L)	272476-3		190-2120	—
VOLVO: S70					
5 Cylinder					
2000-98	2319 (2.3L) Inc. Turbo w/ 2x7spl. Timing Pulley	272476-3		190-2120	—
2000-98	2319 (2.3L) Inc. Turbo w/ 3x4+2spl. Timing Pulley	271985-4		190-1080	—
2000-98	2435 (2.4L) Inc. Turbo w/ 2x7spl. Timing Pulley	272476-3		190-2120	—
2000-98	2435 (2.4L) Inc. Turbo w/ 3x4+2spl. Timing Pulley	271985-4		190-1080	—
VOLVO: S90					
6 Cylinder					
1998-97	2922 (2.9L)	271984-7		190-2090	—
VOLVO: V40					
4 Cylinder					
2004-00	1900 (1.9L)	272476-3		190-2120	—
VOLVO: V70					
5 Cylinder					
2004-98	2435 (2.4L) Inc. Turbo w/ 2x7spl. Timing Pulley	272476-3		190-2120	—
2004-98	2435 (2.4L) Inc. Turbo w/ 3x4+2spl. Timing Pulley	271985-4		190-1080	—

WATER PUMPS

				WATER PUMP	
YEAR	MODEL	O.E. NO.	O.E. CASTING	STANDARD	PERFORMANCE
VOLVO: V90					
6 Cylinder					
1998-97	2922 (2.9L)	271984-7		190-2090	—
VOLVO: XC70					
5 Cylinder					
2002-99	2435 (2.4L)	272476-3		190-2120	—
2004-03	2500 (2.5L)	272476-3		190-2120	—
VOLVO: XC90					
5 Cylinder					
2004-03	2500 (2.5L)	272476-3		190-2120	—
6 Cylinder					
2004-03	2917 (2.9L)	274216-1		190-2120	—

Buyer's Guide / Numerical Listing

Part No.	Make	Model	Year	Cyl.	Engine
113-2120	JAGUAR	XJ-6, XJ-6L	1994	6	3980 (4.0L)
	JAGUAR	XJR	1997-95	6	3980 (4.0L)
	JAGUAR	XJS	1996-95	6	3980 (4.0L)
115-2090	BMW	530 Series	2005-01	6	3000 (3.0L) 530i, 530iT
	BMW	X5	2005-01	6	2979 (3.0L)
120-1300	DODGE	Neon (Inc. Neon SRT-4)	2005-95	4	122 (2.0L)
120-3072	DODGE LIGHT DUTY TRUCKS	Ram 1500-3500 (1/2, 3/4, 1 Ton)	2006-94		359 (5.9L) Diesel Cummins Turbo Diesel
120-4190	CHRYSLER	Sebring	2006-01	V-6	167 (2.7L) 4 Door Sedan
	DODGE	Stratus	2006-01	V-6	167 (2.7L) 4 Door Sedan
120-4220	CHRYSLER	PT Cruiser	2006-03	4	148 (2.4L) w/o Turbo
	CHRYSLER	Sebring	2006-01	4	148 (2.4L) 4 Door Sedan
	DODGE	Stratus	2006-97	4	148 (2.4L) DOHC 4 Door
	DODGE LIGHT DUTY TRUCKS	Caravan, Grand Caravan	2006-97	4	148 (2.4L)
	JEEP	Wrangler	2006-03	4	148 (2.4L) (1)
120-4230	CHRYSLER LIGHT DUTY TRUCKS	Town and Country Van	2005-01	V-6	201 (3.3L) (R)
	CHRYSLER LIGHT DUTY TRUCKS	Town and Country Van	2005-01	V-6	230 (3.8L) (L)
	DODGE LIGHT DUTY TRUCKS	Caravan, Grand Caravan	2005-01	V-6	201 (3.3L)
	DODGE LIGHT DUTY TRUCKS	Caravan, Grand Caravan	2005-01	V-6	230 (3.8L)
120-4340	JEEP	Wrangler	2006-00	6	242 (4.0L) (S)
120-4350	DODGE LIGHT DUTY TRUCKS	Dakota	2005-04	V-6	226 (3.7L)
	DODGE LIGHT DUTY TRUCKS	Dakota	2005-00	V-8	285 (4.7L)
	DODGE LIGHT DUTY TRUCKS	Durango	2005-04	V-6	226 (3.7L)
	DODGE LIGHT DUTY TRUCKS	Durango	2005-00	V-8	285 (4.7L)
	DODGE LIGHT DUTY TRUCKS	Ram 1500-3500 (1/2, 3/4, 1 Ton)	2005-02	V-6	226 (3.7L)
	DODGE LIGHT DUTY TRUCKS	Ram 1500-3500 (1/2, 3/4, 1 Ton)	2005-02	V-8	287 (4.7L)
	JEEP	Grand Cherokee	2006-05	V-6	226 (3.7L) (K)
	JEEP	Grand Cherokee	2006-99	V-8	285 (4.7L)
	JEEP	Liberty	2006-02	V-6	226 (3.7L) (K)
	120-4360	CHRYSLER	PT Cruiser	2006-03	4
DODGE		Neon (Inc. Neon SRT-4)	2005-03	4	148 (2.4L) Turbo
120-4370	DODGE LIGHT DUTY TRUCKS	Durango	2005-04	V-8	345 (5.7L)
	DODGE LIGHT DUTY TRUCKS	Ram 1500-3500 (1/2, 3/4, 1 Ton)	2006-03	V-8	345 (5.7L)
125-1620	FORD LIGHT DUTY TRUCKS	Pickup F150 1/2 Ton	1992	L-6	330 (4.9L) (Y) 5.4 in. Hub Ht.
125-1720	FORD LIGHT DUTY TRUCKS	Pickup F150 1/2 Ton	1992	L-6	330 (4.9L) (Y) 5.0 in. Hub Ht.
125-1790	FORD LIGHT DUTY TRUCKS	Windstar	1995	V-6	232 (3.8L) (4)
125-1820	FORD	Taurus	2005-96	V-6	183 (3.0L) (1,2) Flex Fuel
	FORD	Taurus	2005-96	V-6	183 (3.0L) (U) Gas OHV 12 Valve
	MERCURY	Sable	2005-96	V-6	182 (3.0L) (U) OHV, 12 Valve
125-1830	MERCURY	Marauder	2004-03	V-8	281 (4.6L) (W) w/ Long Housing, Hub Height 3.423in. 8 vane impeller
125-1850	FORD LIGHT DUTY TRUCKS	Ranger	2005-95	V-6	183 (3.0L) (U, V)
	MAZDA LIGHT DUTY TRUCKS	B3000 Pickup	2005-95	V-6	2954 (3.0L)
125-1910	FORD	Taurus	2003	V-6	183 (3.0L) (S) DOHC 24 Valve To 4/1/2003
	FORD	Taurus	2002-01	V-6	183 (3.0L) (S) DOHC 24 Valve
	FORD LIGHT DUTY TRUCKS	Escape	2003-01	V-6	182 (3.0L) (1) To 4/1/2003
	MERCURY	Sable	2004-01	V-6	182 (3.0L) (S) DOHC, 24 Valve To 4/1/04
125-1970	FORD LIGHT DUTY TRUCKS	Freestar	2005-04	V-6	242 (3.9L) (6)
	FORD LIGHT DUTY TRUCKS	Freestar	2005-04	V-6	256 (4.2L) (2)
	FORD LIGHT DUTY TRUCKS	Windstar	2003-96	V-6	232 (3.8L) (4)
	MERCURY	Monterey	2005-04	V-6	256 (4.2L) (2)
125-1980	FORD LIGHT DUTY TRUCKS	Van E250 - 3/4 Ton	1998-97	V-8	281 (4.6L) (6)
125-2101	FORD LIGHT DUTY TRUCKS	Pickup F150 1/2 Ton	2005-97	V-6	256 (4.2L) (2)
125-2102	FORD LIGHT DUTY TRUCKS	Explorer	2005-97	V-6	244 (4.0L) (E, K) SOHC
	FORD LIGHT DUTY TRUCKS	Ranger	2005-01	V-6	244 (4.0L) (E) SOHC
	MAZDA LIGHT DUTY TRUCKS	B4000 Pickup	2005-01	V-6	4016 (4.0L)
	MERCURY LIGHT DUTY TRUCKS	Mountaineer	2005-98	V-6	245 (4.0L) (E, K)
125-5721	FORD LIGHT DUTY TRUCKS	Van E250 - 3/4 Ton	1995-94	V-8	446 (7.3L) (F) w/ bleeder tubing
	FORD LIGHT DUTY TRUCKS	Van E350 - 1 Ton	1995-94	V-8	446 (7.3L) (F) w/ bleeder tubing
	FORD LIGHT DUTY TRUCKS	F59 Stripped Chassis	1996-95	V-8	446 (7.3L) (F) w/ bleeder tubing
	FORD LIGHT DUTY TRUCKS	Pickup F250 3/4 Ton	1995-94	V-8	446 (7.3L) (F) w/ bleeder tubing
	FORD LIGHT DUTY TRUCKS	Pickup F350 1 Ton	1995-94	V-8	446 (7.3L) (F) w/ bleeder tubing
	FORD LIGHT DUTY TRUCKS	Pickup F350 Super Duty 1 Ton	1995-94	V-8	446 (7.3L) (F) w/ bleeder tubing
125-5920	FORD LIGHT DUTY TRUCKS	Excursion	2005-00	V-10	415 (6.8L) (S)
	FORD LIGHT DUTY TRUCKS	Van E350 - 1 Ton	2005-97	V-10	415 (6.8L) (S)
	FORD LIGHT DUTY TRUCKS	Van E450	2005-01	V-10	415 (6.8L) (S)
	FORD LIGHT DUTY TRUCKS	Van E Super Duty	2005-97	V-10	415 (6.8L) (S)
	FORD LIGHT DUTY TRUCKS	Pickup F250 Super Duty 3/4 Ton	2005-99	V-10	415 (6.8L) (S)
	FORD LIGHT DUTY TRUCKS	Pickup F350 Super Duty 1 Ton	2005-99	V-10	415 (6.8L) (S)
	FORD LIGHT DUTY TRUCKS	Pickup F450 Super Duty	2005-99	V-10	415 (6.8L) (S)
	FORD LIGHT DUTY TRUCKS	Pickup F550 Super Duty	2005-99	V-10	415 (6.8L) (S)

Buyer's Guide / Numerical Listing

Part No.	Make	Model	Year	Cyl.	Engine
125-5950	FORD	Mustang	2005	V-8	281 (4.6L)
	MERCURY	Grand Marquis	2002-99	V-8	281 (4.6L) (W) w/ Police, 3.23 7 vane impeller, Hub Height 3.423in.
125-5970	FORD	LTD Crown Victoria	2005-99	V-8	281 (4.6L) (W,9) w/ Short Housing, Hub Height 2.578
	LINCOLN	Town Car	2005	V-8	281 (4.6L) (W)
	MERCURY	Grand Marquis	2005-03	V-8	281 (4.6L) (W) SOHC
	MERCURY	Marauder	2004-03	V-8	281 (4.6L) (W) w/ Short Housing, Hub Height 2.578in
125-5990	FORD LIGHT DUTY TRUCKS	Explorer	2005-02	V-8	281 (4.6L) (W)
	MERCURY LIGHT DUTY TRUCKS	Mountaineer	2005-02	V-8	281 (4.6L) (W)
125-6000	FORD	Focus	2005-04	4	140 (2.3L)
	FORD	Focus	2005-04	4	1989 (2.0) DOHC Fr. 4/5/2004
	FORD LIGHT DUTY TRUCKS	Escape	2005	4	140 (2.3L) Inc. Escape Hybrid
	FORD LIGHT DUTY TRUCKS	Ranger	2005-01	4	140 (2.3L) (D)
	MAZDA	3	2005-04	4	2000 (2.0L)
	MAZDA	3	2005-04	4	2254 (2.3L)
	MAZDA	6	2005-03	4	2254 (2.3L)
	MAZDA LIGHT DUTY TRUCKS	Tribute	2005	4	2261 (2.3L)
	MERCURY	Mariner	2005	4	140 (2.3L)
125-6030	FORD	Thunderbird	2005-02	V-8	242 (3.9L) (A)
	JAGUAR	S Type	2002-00	V-8	3996 (4.0L)
	JAGUAR	XJ-6, XJ-6L	2003-97	V-8	3996 (4.0L)
	LINCOLN	LS	2005-00	V-8	242 (3.9L) (A)
125-6040	JAGUAR	S Type	2003	V-6	2967 (3.0L)
	LINCOLN	LS	2005-03	V-6	181 (3.0L) (S)
125-6050	FORD LIGHT DUTY TRUCKS	Excursion	2005-03	V-6	330 (5.4L) (L)
	FORD LIGHT DUTY TRUCKS	Expedition	2005-03	V-8	330 (5.4L) (L)
	FORD LIGHT DUTY TRUCKS	Van E150 - 1/2 Ton	2005-04	V-8	281 (4.6L) (W)
	FORD LIGHT DUTY TRUCKS	Van E150 - 1/2 Ton	2005-03	V-8	330 (5.4L)
	FORD LIGHT DUTY TRUCKS	Van E250 - 3/4 Ton	2005-04	V-8	281 (4.6L) (W)
	FORD LIGHT DUTY TRUCKS	Van E250 - 3/4 Ton	2005-03	V-8	330 (5.4L)
	FORD LIGHT DUTY TRUCKS	Van E350 - 1 Ton	2005-03	V-8	330 (5.4L)
	FORD LIGHT DUTY TRUCKS	Van E450	2005-03	V-8	330 (5.4L)
	FORD LIGHT DUTY TRUCKS	Pickup F150 1/2 Ton	2005-03	V-8	281 (4.6L) (W)
	FORD LIGHT DUTY TRUCKS	Pickup F150 1/2 Ton	2005-03	V-8	330 (5.4L) (L)
	FORD LIGHT DUTY TRUCKS	Pickup F250 3/4 Ton	2005-03	V-8	281 (4.6L) (W)
	FORD LIGHT DUTY TRUCKS	Pickup F250 3/4 Ton	2005-03	V-8	330 (5.4L) (L)
	FORD LIGHT DUTY TRUCKS	Pickup F250 Super Duty 3/4 Ton	2005-03	V-8	330 (5.4L) (L)
	FORD LIGHT DUTY TRUCKS	Pickup F350 Super Duty 1 Ton	2005-03	V-8	330 (5.4L) (L)
	LINCOLN	Aviator	2005-03	V-8	281 (4.6L)
	LINCOLN	Navigator	2005-02	V-8	330 (5.4L) (R)
	125-6060	FORD	Taurus	2005-04	V-6
FORD		Taurus	2003	V-6	183 (3.0L) (S) DOHC 24 Valve Fr. 4/1/2003
FORD LIGHT DUTY TRUCKS		Escape	2005-03	V-6	182 (3.0L) (1) Fr. 4/1/2003
MAZDA LIGHT DUTY TRUCKS		MPV	2005-04	V-6	2967 (3.0L)
MAZDA LIGHT DUTY TRUCKS		Tribute	2005-01	V-6	2967 (3.0L)
MERCURY		Sable	2005-04	V-6	182 (3.0L) (S) DOHC, 24 Valve From 4/1/04
130-1480	BUICK	Century (Inc. Century Estate Wagon)	2005-00	V-6	189 (3.1L)
	BUICK	Rendezvous	2005-02	V-6	207 (3.4L)
	CHEVROLET LIGHT DUTY TRUCKS	Venture Van	2005-97	V-6	207 (3.4L)
	CHRYSLER	Crossfire	2005-97	V-6	195 (3.2L)
130-1780	BUICK	LeSabre (Inc. LeSabre Estate Wagon)	2005-96	V-6	231 (3.8L)
	BUICK	Park Avenue (Inc. Park Avenue Ultra)	2005-96	V-6	231 (3.8L)
	CHEVROLET	Impala	2005-00	V-6	231 (3.8L) Inc. Impala SS
	CHEVROLET	Monte Carlo	2005-98	V-6	231 (3.8L)
	PONTIAC	Bonneville	2005-96	V-6	230 (3.8L) (K, 1)
	PONTIAC	Grand Prix	2005-97	V-6	230 (3.8L) (1,2,4,K)
130-1800	SATURN	SC Series	2002-95	4	116 (1.9L) (7, 8)
	SATURN	SL Series	2002-95	4	116 (1.9L) (7, 8)
	SATURN	SW Series	2002-95	4	116 (1.9L) (7, 8)
130-1820	CHEVROLET LIGHT DUTY TRUCKS	Astro Van	2005-96	V-6	262 (4.3L)
	CHEVROLET LIGHT DUTY TRUCKS	Van Express G1500 - 1/2 Ton	2006-96	V-6	262 (4.3L)
	CHEVROLET LIGHT DUTY TRUCKS	Van Express G2500 - 3/4 Ton	2006-96	V-6	262 (4.3L)
	CHEVROLET LIGHT DUTY TRUCKS	Van G1500 - 1/2 Ton	2006-96	V-6	262 (4.3L)
	CHEVROLET LIGHT DUTY TRUCKS	Van G2500 - 3/4 Ton	2006-96	V-6	262 (4.3L)
	CHEVROLET LIGHT DUTY TRUCKS	Van G3500 - 1 Ton	2006-96	V-6	262 (4.3L)
	CHEVROLET LIGHT DUTY TRUCKS	Blazer (Compact S10)	2005-96	V-6	262 (4.3L)
	CHEVROLET LIGHT DUTY TRUCKS	S-10 Pickup	2005-96	V-6	262 (4.3L)
	CHEVROLET LIGHT DUTY TRUCKS	Pickup Silverado 2WD - 1/2 Ton	2006-02	V-6	262 (4.3L) (X) Flex Fuel

Buyer's Guide / Numerical Listing

Part No.	Make	Model	Year	Cyl.	Engine
130-1820 (Cont.)	CHEVROLET LIGHT DUTY TRUCKS	Pickup Silverado 2WD - 3/4 Ton	2006-02	V-6	262 (4.3L) (X) Flex Fuel
	CHEVROLET LIGHT DUTY TRUCKS	Pickup Silverado 4WD - 1/2 Ton	2006-02	V-6	262 (4.3L) (X) Flex Fuel
	CHEVROLET LIGHT DUTY TRUCKS	Pickup Silverado 4WD - 3/4 Ton	2006-02	V-6	262 (4.3L) (X) Flex Fuel
	GMC LIGHT DUTY TRUCKS	Van Savana G1500 - 1/2 Ton	2006-96	V-6	262 (4.3L) (W, X)
	GMC LIGHT DUTY TRUCKS	Van Savana G2500 - 3/4 Ton	2006-96	V-6	262 (4.3L) (W, X)
	GMC LIGHT DUTY TRUCKS	Safari Van	2005-98	V-6	262 (4.3L) (W, X)
	GMC LIGHT DUTY TRUCKS	Pickup Sierra 2WD - 1/2 Ton (Inc. HD)	2006-99	V-6	262 (4.3L) (W, X)
	GMC LIGHT DUTY TRUCKS	Pickup Sierra 4WD - 1/2 Ton (Inc. HD)	2006-99	V-6	262 (4.3L) (W, X)
130-1830	CHEVROLET LIGHT DUTY TRUCKS	Suburban C10 / C1500 - 1/2 Ton 2WD	1994-92	V-8	379 (6.2L)
	CHEVROLET LIGHT DUTY TRUCKS	Suburban C20 / C2500 - 3/4 Ton 2WD	1994-92	V-8	379 (6.2L)
	CHEVROLET LIGHT DUTY TRUCKS	Suburban K10 / K1500 - 1/2 Ton 4WD	1994-92	V-8	379 (6.2L)
	CHEVROLET LIGHT DUTY TRUCKS	Suburban K20 / K2500 - 3/4 Ton 4WD	1994-92	V-8	379 (6.2L)
	CHEVROLET LIGHT DUTY TRUCKS	Suburban R10 / R1500 - 1/2 Ton 2WD	1994-92	V-8	379 (6.2L)
	CHEVROLET LIGHT DUTY TRUCKS	Suburban R20 / R2500 - 3/4 Ton 2WD	1994-92	V-8	379 (6.2L)
	CHEVROLET LIGHT DUTY TRUCKS	Suburban V10 / V1500 - 1/2 Ton 4WD	1994-92	V-8	379 (6.2L)
	CHEVROLET LIGHT DUTY TRUCKS	Suburban V20 / V2500 - 3/4 Ton 4WD	1994-92	V-8	379 (6.2L)
130-1840	CADILLAC	Deville, Deville Concours	2005-96	V-8	281 (4.6L)
	CADILLAC	Hearse	2005-98	V-8	281 (4.6L)
	PONTIAC	Bonneville	2005-04	V-8	281 (4.6L) (Y)
130-5130	BUICK	Rendezvous	2006-04	V-6	220 (3.6L)
	CADILLAC	CTS	2006-04	V-6	220 (3.6L)
	CADILLAC	SRX	2006-04	V-6	220 (3.6L)
	CADILLAC	STS	2006-05	V-6	220 (3.6L)
130-5980	CHEVROLET LIGHT DUTY TRUCKS	Pickup Silverado 2WD - 1/2 Ton	2005-01	V-8	400 (6.6L) Duramax Diesel
	CHEVROLET LIGHT DUTY TRUCKS	Pickup Silverado 2WD - 3/4 Ton	2005-01	V-8	400 (6.6L) Duramax Diesel
	CHEVROLET LIGHT DUTY TRUCKS	Pickup Silverado 2WD - 1 Ton	2005-01	V-8	400 (6.6L) Duramax Diesel
	CHEVROLET LIGHT DUTY TRUCKS	Pickup Silverado 4WD - 1/2 Ton	2005-01	V-8	400 (6.6L) Duramax Diesel
	CHEVROLET LIGHT DUTY TRUCKS	Pickup Silverado 4WD - 3/4 Ton	2005-01	V-8	400 (6.6L) Duramax Diesel
	CHEVROLET LIGHT DUTY TRUCKS	Pickup Silverado 4WD - 1 Ton	2005-01	V-8	400 (6.6L) Duramax Diesel
	CHEVROLET LIGHT DUTY TRUCKS	Suburban C10 / C1500 - 1/2 Ton 2WD	2005-01	V-8	400 (6.6L) Duramax Diesel
	CHEVROLET LIGHT DUTY TRUCKS	Suburban C20 / C2500 - 3/4 Ton 2WD	2005-01	V-8	400 (6.6L) Duramax Diesel
	CHEVROLET LIGHT DUTY TRUCKS	Suburban K10 / K1500 - 1/2 Ton 4WD	2005-01	V-8	400 (6.6L) Duramax Diesel
	CHEVROLET LIGHT DUTY TRUCKS	Suburban K20 / K2500 - 3/4 Ton 4WD	2005-01	V-8	400 (6.6L) Duramax Diesel
	CHEVROLET LIGHT DUTY TRUCKS	Suburban R10 / R1500 - 1/2 Ton 2WD	2005-01	V-8	400 (6.6L) Duramax Diesel
	CHEVROLET LIGHT DUTY TRUCKS	Suburban R20 / R2500 - 3/4 Ton 2WD	2005-01	V-8	400 (6.6L) Duramax Diesel
	CHEVROLET LIGHT DUTY TRUCKS	Suburban V10 / V1500 - 1/2 Ton 4WD	2005-01	V-8	400 (6.6L) Duramax Diesel
	CHEVROLET LIGHT DUTY TRUCKS	Suburban V20 / V2500 - 3/4 Ton 4WD	2005-01	V-8	400 (6.6L) Duramax Diesel
	GMC LIGHT DUTY TRUCKS	Pickup Sierra 2WD - 1 Ton (Inc. HD)	2005-01	V-8	400 (6.6L) Duramax Diesel
	GMC LIGHT DUTY TRUCKS	Pickup Sierra 2WD - 3/4 Ton (Inc. HD)	2005-01	V-8	400 (6.6L) Duramax Diesel
GMC LIGHT DUTY TRUCKS	Pickup Sierra 4WD - 1 Ton (Inc. HD)	2005-01	V-8	400 (6.6L) Duramax Diesel	
GMC LIGHT DUTY TRUCKS	Pickup Sierra 4WD - 3/4 Ton (Inc. HD)	2005-01	V-8	400 (6.6L) Duramax Diesel	
130-7090	CHEVROLET LIGHT DUTY TRUCKS	Series 40	2006-03	V-8	496 (8.1L) Kodiak C4500
	CHEVROLET LIGHT DUTY TRUCKS	Series 50	2006-03	V-8	496 (8.1L) Kodiak C5500
	CHEVROLET LIGHT DUTY TRUCKS	Series 60	2006-03	V-8	496 (8.1L) Kodiak C6500
	CHEVROLET LIGHT DUTY TRUCKS	Series 70	2006-03	V-8	496 (8.1L) Kodiak C7500
	CHEVROLET LIGHT DUTY TRUCKS	Series 80	2006-03	V-8	496 (8.1L) Kodiak C8500
	GMC TRUCK Medium & Heavy Duty	Series 40-90	2006-03	V-8	496 (8.1L) (E)
	GMC TRUCK Medium & Heavy Duty	C6 Series	2006-03	V-8	496 (8.1L) (E) Topkick
	GMC TRUCK Medium & Heavy Duty	C7 Series	2006-03	V-8	496 (8.1L) (E) Topkick
130-7200	CHEVROLET LIGHT DUTY TRUCKS	Van Express G1500 - 1/2 Ton	1998-97	V-8	395 (6.5L) (F) Diesel
	CHEVROLET LIGHT DUTY TRUCKS	Van G1500 - 1/2 Ton	1998-97	V-8	395 (6.5L) (F) Diesel
	CHEVROLET LIGHT DUTY TRUCKS	Van G2500 - 3/4 Ton	1998-97	V-8	395 (6.5L) (F) Diesel
	CHEVROLET LIGHT DUTY TRUCKS	Van G3500 - 1 Ton	1998-97	V-8	395 (6.5L) (F) Diesel
	GMC LIGHT DUTY TRUCKS	Van G35/3500 - 1 Ton	1998-97	V-8	395 (6.5L) (F) Diesel
130-7260	CHEVROLET LIGHT DUTY TRUCKS	Avalanche	2006-02	V-8	496 (8.1L)
	CHEVROLET LIGHT DUTY TRUCKS	Pickup Silverado 2WD - 1/2 Ton	2006-01	V-8	496 (8.1L) Inc.1500HD
	CHEVROLET LIGHT DUTY TRUCKS	Pickup Silverado 2WD - 3/4 Ton	2006-01	V-8	496 (8.1L) Inc.2500HD
	CHEVROLET LIGHT DUTY TRUCKS	Pickup Silverado 2WD - 1 Ton	2006-01	V-8	496 (8.1L)
	CHEVROLET LIGHT DUTY TRUCKS	Pickup Silverado 4WD - 1/2 Ton	2006-01	V-8	496 (8.1L) Inc.1500HD
	CHEVROLET LIGHT DUTY TRUCKS	Pickup Silverado 4WD - 3/4 Ton	2006-01	V-8	496 (8.1L) Inc.2500HD
	CHEVROLET LIGHT DUTY TRUCKS	Pickup Silverado 4WD - 1 Ton	2006-01	V-8	496 (8.1L)
	CHEVROLET LIGHT DUTY TRUCKS	Suburban C10 / C1500 - 1/2 Ton 2WD	2006-01	V-8	496 (8.1L)
	CHEVROLET LIGHT DUTY TRUCKS	Suburban C20 / C2500 - 3/4 Ton 2WD	2006-01	V-8	496 (8.1L)
	CHEVROLET LIGHT DUTY TRUCKS	Suburban K10 / K1500 - 1/2 Ton 4WD	2006-01	V-8	496 (8.1L)
	CHEVROLET LIGHT DUTY TRUCKS	Suburban K20 / K2500 - 3/4 Ton 4WD	2006-01	V-8	496 (8.1L)
	CHEVROLET LIGHT DUTY TRUCKS	Suburban R10 / R1500 - 1/2 Ton 2WD	2006-01	V-8	496 (8.1L)
	CHEVROLET LIGHT DUTY TRUCKS	Suburban R20 / R2500 - 3/4 Ton 2WD	2006-01	V-8	496 (8.1L)
	CHEVROLET LIGHT DUTY TRUCKS	Suburban V10 / V1500 - 1/2 Ton 4WD	2006-01	V-8	496 (8.1L)
	CHEVROLET LIGHT DUTY TRUCKS	Suburban V20 / V2500 - 3/4 Ton 4WD	2006-01	V-8	496 (8.1L)
	GMC LIGHT DUTY TRUCKS	Pickup Sierra 2WD - 1 Ton (Inc. HD)	2006-01	V-8	496 (8.1L) (G)

Buyer's Guide / Numerical Listing

Part No.	Make	Model	Year	Cyl.	Engine
130-7260 (Cont.)	GMC LIGHT DUTY TRUCKS	Pickup Sierra 2WD - 1/2 Ton (Inc. HD)	2006-01	V-8	496 (8.1L) (G)
	GMC LIGHT DUTY TRUCKS	Pickup Sierra 2WD - 3/4 Ton (Inc. HD)	2006-01	V-8	496 (8.1L) (G)
	GMC LIGHT DUTY TRUCKS	Pickup Sierra 4WD - 1 Ton (Inc. HD)	2006-01	V-8	496 (8.1L) (G)
	GMC LIGHT DUTY TRUCKS	Pickup Sierra 4WD - 1/2 Ton (Inc. HD)	2006-01	V-8	496 (8.1L) (G)
	GMC LIGHT DUTY TRUCKS	Pickup Sierra 4WD - 3/4 Ton (Inc. HD)	2006-01	V-8	496 (8.1L) (G)
	GMC LIGHT DUTY TRUCKS	Yukon XL 1500	2006-01	V-8	496 (8.1L) (G)
	GMC LIGHT DUTY TRUCKS	Yukon XL 2500	2006-01	V-8	496 (8.1L) (G)
	GMC LIGHT DUTY TRUCKS	Yukon	2006-01	V-8	496 (8.1L) (G)
130-7290	CHEVROLET	Corvette	2004-97	V-8	350 (5.7L)
	PONTIAC	GTO	2005	V-8	364 (6.0L) (U)
130-7340	CADILLAC	Escalade	2003-02	V-8	323 (5.3L)
	CADILLAC	Escalade	2003-02	V-8	364 (6.0L)
	CHEVROLET LIGHT DUTY TRUCKS	Avalanche	2003-02	V-8	323 (5.3L)
	GMC LIGHT DUTY TRUCKS	Yukon XL 1500	2003-00	V-8	364 (6.0L) (U)
	GMC LIGHT DUTY TRUCKS	Yukon	2003-00	V-8	323 (5.3L) (T)
	ISUZU LIGHT DUTY TRUCKS	Ascender	2005-03	V-8	323 (5.3L)
	130-7341	BUICK	Rainier	2005-04	V-8
CADILLAC		Escalade	2005-04	V-8	323 (5.3L)
CADILLAC		Escalade	2005-04	V-8	364 (6.0L)
CHEVROLET LIGHT DUTY TRUCKS		Avalanche	2006-04	V-8	323 (5.3L)
CHEVROLET LIGHT DUTY TRUCKS		Van Express G1500 - 1/2 Ton	2006-04	V-8	294 (4.8L)
CHEVROLET LIGHT DUTY TRUCKS		Van Express G1500 - 1/2 Ton	2006-04	V-8	323 (5.3L) w/ 4 Spd. Auto Trans.
CHEVROLET LIGHT DUTY TRUCKS		Van Express G1500 - 1/2 Ton	2006-04	V-8	364 (6.0L)
CHEVROLET LIGHT DUTY TRUCKS		Van Express G2500 - 3/4 Ton	2006-04	V-8	294 (4.8L)
CHEVROLET LIGHT DUTY TRUCKS		Van Express G2500 - 3/4 Ton	2006-04	V-8	323 (5.3L) w/ 4 Spd. Auto Trans.
CHEVROLET LIGHT DUTY TRUCKS		Van Express G2500 - 3/4 Ton	2006-04	V-8	364 (6.0L)
CHEVROLET LIGHT DUTY TRUCKS		Van Express G3500 - 1 Ton	2006-04	V-8	294 (4.8L)
CHEVROLET LIGHT DUTY TRUCKS		Van Express G3500 - 1 Ton	2006-04	V-8	323 (5.3L) w/ 4 Spd. Auto Trans.
CHEVROLET LIGHT DUTY TRUCKS		Van Express G3500 - 1 Ton	2006-04	V-8	364 (6.0L)
CHEVROLET LIGHT DUTY TRUCKS		Van G1500 - 1/2 Ton	2006-04	V-8	294 (4.8L)
CHEVROLET LIGHT DUTY TRUCKS		Van G1500 - 1/2 Ton	2006-04	V-8	323 (5.3L) w/ 4 Spd. Auto Trans.
CHEVROLET LIGHT DUTY TRUCKS		Van G1500 - 1/2 Ton	2006-04	V-8	364 (6.0L)
CHEVROLET LIGHT DUTY TRUCKS		Van G2500 - 3/4 Ton	2006-04	V-8	294 (4.8L)
CHEVROLET LIGHT DUTY TRUCKS		Van G2500 - 3/4 Ton	2006-04	V-8	323 (5.3L) w/ 4 Spd. Auto Trans.
CHEVROLET LIGHT DUTY TRUCKS		Van G2500 - 3/4 Ton	2006-04	V-8	364 (6.0L)
CHEVROLET LIGHT DUTY TRUCKS		Van G3500 - 1 Ton	2006-04	V-8	294 (4.8L)
CHEVROLET LIGHT DUTY TRUCKS		Van G3500 - 1 Ton	2006-04	V-8	323 (5.3L) w/ 4 Spd. Auto Trans.
CHEVROLET LIGHT DUTY TRUCKS		Van G3500 - 1 Ton	2006-04	V-8	364 (6.0L)
CHEVROLET LIGHT DUTY TRUCKS		SSR	2006-05	V-8	364 (6.0L)
CHEVROLET LIGHT DUTY TRUCKS		Pickup Silverado 2WD - 1/2 Ton	2006-04	V-8	294 (4.8L)
CHEVROLET LIGHT DUTY TRUCKS		Pickup Silverado 2WD - 1/2 Ton	2006-04	V-8	323 (5.3L)
CHEVROLET LIGHT DUTY TRUCKS		Pickup Silverado 2WD - 1/2 Ton	2006-04	V-8	364 (6.0L) Inc.1500HD
CHEVROLET LIGHT DUTY TRUCKS		Pickup Silverado 2WD - 3/4 Ton	2006-04	V-8	294 (4.8L)
CHEVROLET LIGHT DUTY TRUCKS		Pickup Silverado 2WD - 3/4 Ton	2006-04	V-8	323 (5.3L)
CHEVROLET LIGHT DUTY TRUCKS		Pickup Silverado 2WD - 3/4 Ton	2006-04	V-8	364 (6.0L) Inc.2500HD
CHEVROLET LIGHT DUTY TRUCKS		Pickup Silverado 2WD - 1 Ton	2006-04	V-8	294 (4.8L)
CHEVROLET LIGHT DUTY TRUCKS		Pickup Silverado 2WD - 1 Ton	2006-04	V-8	323 (5.3L)
CHEVROLET LIGHT DUTY TRUCKS		Pickup Silverado 2WD - 1 Ton	2006-04	V-8	364 (6.0L)
CHEVROLET LIGHT DUTY TRUCKS		Pickup Silverado 4WD - 1/2 Ton	2006-04	V-8	294 (4.8L)
CHEVROLET LIGHT DUTY TRUCKS		Pickup Silverado 4WD - 1/2 Ton	2006-04	V-8	323 (5.3L)
CHEVROLET LIGHT DUTY TRUCKS		Pickup Silverado 4WD - 1/2 Ton	2006-04	V-8	364 (6.0L) Inc.1500HD
CHEVROLET LIGHT DUTY TRUCKS		Pickup Silverado 4WD - 3/4 Ton	2006-04	V-8	294 (4.8L)
CHEVROLET LIGHT DUTY TRUCKS		Pickup Silverado 4WD - 3/4 Ton	2006-04	V-8	323 (5.3L)
CHEVROLET LIGHT DUTY TRUCKS		Pickup Silverado 4WD - 3/4 Ton	2006-04	V-8	364 (6.0L) Inc.2500HD
CHEVROLET LIGHT DUTY TRUCKS		Pickup Silverado 4WD - 1 Ton	2006-04	V-8	294 (4.8L)
CHEVROLET LIGHT DUTY TRUCKS		Pickup Silverado 4WD - 1 Ton	2006-04	V-8	323 (5.3L)
CHEVROLET LIGHT DUTY TRUCKS		Pickup Silverado 4WD - 1 Ton	2006-04	V-8	364 (6.0L)
CHEVROLET LIGHT DUTY TRUCKS		Suburban C10 / C1500 - 1/2 Ton 2WD	2006-04	V-8	323 (5.3L)
CHEVROLET LIGHT DUTY TRUCKS		Suburban C10 / C1500 - 1/2 Ton 2WD	2006-04	V-8	364 (6.0L)
CHEVROLET LIGHT DUTY TRUCKS		Suburban C20 / C2500 - 3/4 Ton 2WD	2006-04	V-8	323 (5.3L)
CHEVROLET LIGHT DUTY TRUCKS		Suburban C20 / C2500 - 3/4 Ton 2WD	2006-04	V-8	364 (6.0L)
CHEVROLET LIGHT DUTY TRUCKS		Suburban K10 / K1500 - 1/2 Ton 4WD	2006-04	V-8	323 (5.3L)
CHEVROLET LIGHT DUTY TRUCKS		Suburban K10 / K1500 - 1/2 Ton 4WD	2006-04	V-8	364 (6.0L)
CHEVROLET LIGHT DUTY TRUCKS		Suburban K20 / K2500 - 3/4 Ton 4WD	2006-04	V-8	323 (5.3L)
CHEVROLET LIGHT DUTY TRUCKS		Suburban K20 / K2500 - 3/4 Ton 4WD	2006-04	V-8	364 (6.0L)
CHEVROLET LIGHT DUTY TRUCKS		Suburban R10 / R1500 - 1/2 Ton 2WD	2006-04	V-8	323 (5.3L)
CHEVROLET LIGHT DUTY TRUCKS		Suburban R10 / R1500 - 1/2 Ton 2WD	2006-04	V-8	364 (6.0L)
CHEVROLET LIGHT DUTY TRUCKS		Suburban R20 / R2500 - 3/4 Ton 2WD	2006-04	V-8	323 (5.3L)
CHEVROLET LIGHT DUTY TRUCKS		Suburban R20 / R2500 - 3/4 Ton 2WD	2006-04	V-8	364 (6.0L)
CHEVROLET LIGHT DUTY TRUCKS		Suburban V10 / V1500 - 1/2 Ton 4WD	2006-04	V-8	323 (5.3L)
CHEVROLET LIGHT DUTY TRUCKS	Suburban V10 / V1500 - 1/2 Ton 4WD	2006-04	V-8	364 (6.0L)	

Buyer's Guide / Numerical Listing

Part No.	Make	Model	Year	Cyl.	Engine
130-7341 (Cont.)	CHEVROLET LIGHT DUTY TRUCKS	Suburban V20 / V2500 - 3/4 Ton 4WD	2006-04	V-8	323 (5.3L)
	CHEVROLET LIGHT DUTY TRUCKS	Suburban V20 / V2500 - 3/4 Ton 4WD	2006-04	V-8	364 (6.0L)
	CHEVROLET LIGHT DUTY TRUCKS	Tahoe	2006-04	V-8	294 (4.8L)
	CHEVROLET LIGHT DUTY TRUCKS	Tahoe	2006-04	V-8	323 (5.3L)
	CHEVROLET LIGHT DUTY TRUCKS	TrailBlazer	2006	V-8	364 (6.0L) TrailBlazer SS
	CHEVROLET LIGHT DUTY TRUCKS	TrailBlazer	2006-04	V-8	323 (5.3L)
	GMC LIGHT DUTY TRUCKS	Envoy (Inc. Envoy XL, Denali)	2006-03	V-8	323 (5.3L) (P)
	GMC LIGHT DUTY TRUCKS	Van Savana G1500 - 1/2 Ton	2006-04	V-8	323 (5.3L) (T) w/ 4spd. Auto Trans.
	GMC LIGHT DUTY TRUCKS	Van Savana G2500 - 3/4 Ton	2006-04	V-8	294 (4.8L) (V)
	GMC LIGHT DUTY TRUCKS	Van Savana G2500 - 3/4 Ton	2006-04	V-8	323 (5.3L) (T) w/ 4spd. Auto Trans.
	GMC LIGHT DUTY TRUCKS	Van Savana G2500 - 3/4 Ton	2006-04	V-8	364 (6.0L) (U)
	GMC LIGHT DUTY TRUCKS	Van Savana G3500 - 1 Ton	2006-04	V-8	364 (6.0L) (U)
	GMC LIGHT DUTY TRUCKS	Pickup Sierra 2WD - 1 Ton (Inc. HD)	2006-04	V-8	364 (6.0L) (U)
	GMC LIGHT DUTY TRUCKS	Pickup Sierra 2WD - 1/2 Ton (Inc. HD)	2006-04	V-8	323 (5.3L) (T, Z)
	GMC LIGHT DUTY TRUCKS	Pickup Sierra 2WD - 1/2 Ton (Inc. HD)	2006-04	V-8	294 (4.8L) (V)
	GMC LIGHT DUTY TRUCKS	Pickup Sierra 2WD - 1/2 Ton (Inc. HD)	2006-04	V-8	364 (6.0L) (N, V)
	GMC LIGHT DUTY TRUCKS	Pickup Sierra 2WD - 3/4 Ton (Inc. HD)	2006-04	V-8	323 (5.3L) (T, Z)
	GMC LIGHT DUTY TRUCKS	Pickup Sierra 2WD - 3/4 Ton (Inc. HD)	2006-04	V-8	364 (6.0L) (U)
	GMC LIGHT DUTY TRUCKS	Pickup Sierra 4WD - 1 Ton (Inc. HD)	2006-04	V-8	364 (6.0L) (U)
	GMC LIGHT DUTY TRUCKS	Pickup Sierra 4WD - 1/2 Ton (Inc. HD)	2006-04	V-8	323 (5.3L) (T, Z)
	GMC LIGHT DUTY TRUCKS	Pickup Sierra 4WD - 1/2 Ton (Inc. HD)	2006-04	V-8	294 (4.8L) (V)
	GMC LIGHT DUTY TRUCKS	Pickup Sierra 4WD - 1/2 Ton (Inc. HD)	2006-04	V-8	364 (6.0L) (N, V)
	GMC LIGHT DUTY TRUCKS	Pickup Sierra 4WD - 3/4 Ton (Inc. HD)	2006-04	V-8	323 (5.3L) (T, Z)
	GMC LIGHT DUTY TRUCKS	Pickup Sierra 4WD - 3/4 Ton (Inc. HD)	2006-04	V-8	364 (6.0L) (U)
	GMC LIGHT DUTY TRUCKS	Yukon XL 1500	2006-04	V-8	323 (5.3L) (T, Z)
	GMC LIGHT DUTY TRUCKS	Yukon XL 1500	2006-04	V-8	364 (6.0L) (U)
	GMC LIGHT DUTY TRUCKS	Yukon XL 2500	2006-04	V-8	323 (5.3L) (T, Z)
	GMC LIGHT DUTY TRUCKS	Yukon XL 2500	2006-04	V-8	364 (6.0L) (U)
	GMC LIGHT DUTY TRUCKS	Yukon	2006-04	V-8	294 (4.8L) (V)
	GMC LIGHT DUTY TRUCKS	Yukon	2006-04	V-8	323 (5.3L) (T, Z)
	GMC LIGHT DUTY TRUCKS	Yukon	2006-04	V-8	364 (6.0L) (U) Inc. Denali, Denali XL
	HUMMER	H2 Series	2006-2004	4	364 (6.0L) (U)
	130-7350	CHEVROLET	Cavalier (Inc. Cadet)	2005-02	4
PONTIAC		Grand Am	2005-02	4	134 (2.2L) (F)
PONTIAC		Sunfire	2005-02	4	134 (2.2L) (F)
SATURN		ION	2005-03	4	122 (2.0L) Red Line
SATURN		ION	2005-03	4	134 (2.2L)
SATURN		Vue	2005-02	4	134 (2.2L)
130-7360	PONTIAC	Vibe	2006-03	4	1762 (1.8L) (8) Inc.AWD
	TOYOTA	Carina, Corolla	2005-03	4	1762 (1.8L) 1ZZFE
	TOYOTA	Carina, Corolla	2005	4	1762 (1.8L) 2ZZGE
	TOYOTA	Celica	2005-02	4	1762 (1.8L) 1ZZFE
	TOYOTA	Matrix	2005-03	4	1762 (1.8L) 1ZZFE
	TOYOTA	MR2 Spyder	2005-02	4	1762 (1.8L) 1ZZFE
130-7700	BUICK	Rainier	2006-04	6	256 (4.2L)
	CHEVROLET LIGHT DUTY TRUCKS	Colorado	2006-04	4	169 (2.8L)
	CHEVROLET LIGHT DUTY TRUCKS	Colorado	2006-04	5	211 (3.5L)
	CHEVROLET LIGHT DUTY TRUCKS	TrailBlazer	2006-02	6	256 (4.2L)
	GMC LIGHT DUTY TRUCKS	Canyon	2006-04	4	169 (2.8L) (8)
	GMC LIGHT DUTY TRUCKS	Canyon	2006-04	5	211 (3.5L) (6)
	GMC LIGHT DUTY TRUCKS	Envoy (Inc. Envoy XL, Denali)	2006-02	6	256 (4.2L) (S)
	ISUZU LIGHT DUTY TRUCKS	Ascender	2005-03	6	256 (4.2L)
135-2380	ACURA	CL	2003-01	V-6	3210 (3.2L)
135-1320	HONDA	Civic, CVCC	1995-92	4	1590 (1.6L) D16Z EX, SI w/ VTEC
135-1500	ACURA	TSX	2004	4	2354 (2.4L)
	HONDA	Accord	2004-03	4	2354 (2.4L) DX, EX, LX
	HONDA	Element	2004-03	4	2351 (2.4L)
135-1510	ACURA	RSX	2005-02	4	1998 (2.0L) S
135-1520	ACURA	RSX	2005-02	4	1998 (2.0L)
	HONDA	Civic, CVCC	2005-02	4	1998 (2.0L)
	HONDA LIGHT DUTY TRUCKS	CR-V	2004-02	4	2400 (2.4L) EX, LX
135-1530	ACURA	MDX	2004-03	V-6	3471 (3.5L) J35A5 Inc. Touring
	ACURA	TL	2004	V-6	3210 (3.2L)
	HONDA	Accord	2004-03	V-6	2977 (3.0L) EX, LX
135-2085	ACURA	NSX	2005-97	V-6	2977 (3.0L)
	ACURA	NSX	2005-97	V-6	3179 (3.2L)
135-2090	ACURA	Vigor	1994-92	5	2451 (2.5L)
135-2200	HONDA	Civic Del Sol	1995-94	4	1590 (1.6L) B16A VTEC, DOHC
135-2380	ACURA	TL	2003-99	V-6	3210 (3.2L)
135-2420	HONDA	Civic, CVCC	2005-01	4	1668 (1.7L) D17A 1/2/6/7

Buyer's Guide / Numerical Listing

Part No.	Make	Model	Year	Cyl.	Engine
143-2001	KIA	Spectra	2004-00	4	1793 (1.8L)
145-1390	MAZDA	Miata, MX5	2005-99	4	1839 (1.8L)
146-1110	HYUNDAI	Sonata	2005-99	4	2351 (2.4L)
	KIA	Optima	2005-01	4	2351 (2.4L)
146-1230	HYUNDAI	Accent	1999-95	4	1495 (1.5L) DOHC
146-2020	HYUNDAI	Elantra	2005-99	4	1975 (2.0L)
	KIA	Sportage	2005	4	1975 (2.0L)
146-2070	HYUNDAI	Accent	2005-01	4	1600 (1.6L)
147-2220	MERCEDES BENZ	C Series	2005	V-8	5439 (5.5L) C55 3 Hose Connections
	MERCEDES BENZ	CLK Series	2005-01	V-8	5439 (5.5L) CLK55 3 Hose Connections
	MERCEDES BENZ	G Series	2005-03	V-8	5439 (5.5L) G55 Inc. AMG; 3 Hose Connections
	MERCEDES BENZ	ML Series	2006-02	V-8	4973 (5.0L) ML500 3 Hose Connections
147-2250	MERCEDES BENZ	C Series	2005-01	V-6	2597 (2.6L) C240 2 Hose Connections
	MERCEDES BENZ	C Series	2005-98	V-6	3199 (3.2L) C320 2 Hose Connections
	MERCEDES BENZ	CL Series	2005-00	V-8	4966 (5.0L) CL500 2 Hose Connections
	MERCEDES BENZ	CLK Series	2005-98	V-6	3199 (3.2L) CLK320 2 Hose Connections
	MERCEDES BENZ	CLK Series	2005-03	V-8	5439 (5.5L) CLK500 2 Hose Connections
	MERCEDES BENZ	CLS Series	2006	V-8	4966 (5.0L) CLS500 2 Hose Connections
	MERCEDES BENZ	E Series	2005-03	V-8	4966 (5.0L) E500 2 Hose Connections
	MERCEDES BENZ	G Series	2005-02	V-8	4966 (5.0L) G500 2 Hose Connections
	MERCEDES BENZ	ML Series	2005-03	V-6	3699 (3.7L) ML350 2 Hose Connections
	MERCEDES BENZ	S Series	2006-00	V-8	4266 (4.3L) S430 2 Hose Connections
	MERCEDES BENZ	S Series	2006-00	V-8	4966 (5.0L) S500 2 Hose Connections
148-1170	HYUNDAI	Accent	1999-95	4	1495 (1.5L) SOHC
148-1780	MITSUBISHI	Galant	2004	4	2351 (2.4L)
	MITSUBISHI	Lancer	2004-03	4	2000 (2.0L) Evolution
	MITSUBISHI	Lancer	2004	4	2400 (2.4L) Sportback
	MITSUBISHI LIGHT DUTY TRUCKS	Outlander	2004	4	2351 (2.4L)
148-1790	MITSUBISHI LIGHT DUTY TRUCKS	Montero	2002-01	V-6	3497 (3.5L) 6G74 Engine Vin R
	MITSUBISHI LIGHT DUTY TRUCKS	Montero	2004-03	V-6	3797 (3.8L)
148-1810	MITSUBISHI LIGHT DUTY TRUCKS	Outlander	2003	4	2351 (2.4L)
148-2280	MITSUBISHI	Lancer	2005-02	4	2000 (2.0L)
148-2320	CHRYSLER	Sebring	2005-03	V-6	181 (3.0L) Convertible and Coupe
	DODGE	Stratus	2005-03	V-6	181 (3.0L) Coupe
	MITSUBISHI	Endeavor	2005-04	V-6	3828 (3.8L)
	MITSUBISHI	Galant	2005-00	V-6	3828 (3.8L)
	DODGE	Stratus	2005-01	4	143 (2.4L) SOHC 2 Door
	MITSUBISHI	Galant	2003-99	4	2351 (2.4L)
	INFINITI	G35	2005-03	V-6	3500 (3.5L) VQ35DE
	NISSAN	350Z	2005-03	V-6	3498 (3.5L) VQ35DE
	NISSAN	Altima	2005-02	V-6	3498 (3.5L) VQ35DE
	NISSAN	Maxima	2005-02	V-6	3498 (3.5L) VQ35DE
	NISSAN LIGHT DUTY TRUCKS	Frontier Pickup	2005	V-6	3954 (4.0L)
	NISSAN LIGHT DUTY TRUCKS	Murano	2005-03	V-6	3498 (3.5L) VQ35DE
	NISSAN LIGHT DUTY TRUCKS	Pathfinder	2005	V-6	3954 (4.0L)
	NISSAN LIGHT DUTY TRUCKS	Xterra	2005	V-6	3954 (4.0L)
150-2340	NISSAN	Sentra	2005-02	4	2488 (2.5L) QR25DE
160-1120	SUBARU	Baja	2005-03	4	2458 (2.5L) EJ253 w/o Turbo
	SUBARU	Forester	2005-99	4	2457 (2.5L) w/ MT, X Model
	SUBARU	Legacy	2005-97	4	2457 (2.5L) EJ253
	SUBARU	Outback	2005-98	4	2457 (2.5L) EJ253
160-2070	SUBARU	Outback	2005-01	4	2999 (3.0L) EZ30D
165-1200	SUZUKI LIGHT DUTY TRUCKS	Grand Vitara	2005-99	V-6	2494 (2.5L)
165-2001	SUZUKI	Aerio	2005-04	4	2300 (2.3L)
170-1670	TOYOTA	Celica	1989-86	4	1998 (2.0L) 3SGELC GTS
170-1840	LEXUS	GS430	2005-01	V-8	4300 (4.3L) 3UZ-FE
	LEXUS	GS470	2005-03	V-8	4663 (4.7L) 2UZFE
	LEXUS	LS430	2005-01	V-8	4293 (4.3L) 3UZ-FE Behind Idler
	LEXUS	LX470	2005-98	V-8	4663 (4.7L) 2UZFE
	LEXUS	SC430	2005-02	V-8	4300 (4.3L)
	TOYOTA LIGHT DUTY TRUCKS	4 Runner	2005-03	V-8	4663 (4.7L) 2UZFE
	TOYOTA LIGHT DUTY TRUCKS	Landcruiser	2005-98	V-8	4663 (4.7L) 2UZFE
	TOYOTA LIGHT DUTY TRUCKS	Sequoia	2005-01	V-8	4663 (4.7L) 2UZFE
	TOYOTA LIGHT DUTY TRUCKS	Tundra	2005-00	V-6	4663 (4.7L) 2UZFE
170-1920	LEXUS	RX330	2005-04	V-6	3300 (3.3L) 3MZ-FE Eng. # starts with 0
	LEXUS	RX400H	2006	V-6	3311 (3.3L)
	TOYOTA	Camry	2005-94	V-6	2995 (3.0L) 1MZFE
	TOYOTA	Camry	2005-04	V-6	3300 (3.3L) 3MZFE

Buyer's Guide / Numerical Listing

Part No.	Make	Model	Year	Cyl.	Engine
170-1920 (Cont.)	TOYOTA	Solara	2005-04	V-6	3300 (3.3L) 3MZFE
	TOYOTA LIGHT DUTY TRUCKS	Highlander	2005-04	V-6	3300 (3.3L) 3MZFE
	TOYOTA LIGHT DUTY TRUCKS	Sienna Van	2005-04	V-6	3300 (3.3L) 3MZFE
170-1960	TOYOTA LIGHT DUTY TRUCKS	Tacoma	2003-95	4	2438 (2.4L) 2RZFE w/o By-Pass Tube
	TOYOTA LIGHT DUTY TRUCKS	Tacoma	2003-95	4	2694 (2.7L) 3RZFE w/o By-Pass Tube
170-1970	TOYOTA LIGHT DUTY TRUCKS	Tacoma	2004-03	V-6	3378 (3.4L) 5VZFE w/ By-Pass Tube
	TOYOTA LIGHT DUTY TRUCKS	Tundra	2004	V-6	3378 (3.4L) 5MZFE w/ AT
170-2101	SCION	XA	2005-03	4	1497 (1.5L)
	SCION	XB	2005-03	4	1497 (1.5L)
	TOYOTA	Echo	2005-00	4	1497 (1.5L) 1NZFE
	TOYOTA	Prius	2005-01	4	1497 (1.5L) 1NZFXE Electric/Gas
170-2103	TOYOTA LIGHT DUTY TRUCKS	Tacoma	2000-95	V-6	3378 (3.4L) 5VZFE 2WD w/ AT w/ Column Shift
	TOYOTA LIGHT DUTY TRUCKS	Tundra	2004	V-6	3378 (3.4L) 5MZFE w/ MT
	TOYOTA LIGHT DUTY TRUCKS	Tundra	2003-02	V-6	3378 (3.4L) 5MZFE 2WD w/ AT
170-2107	TOYOTA	Celica	1993-88	4	1998 (2.0L) 3SGTE AWD, Inc. Turbo
	TOYOTA	MR2	1995-91	4	1998 (2.0L) 3SGTE Turbo
170-2380	LEXUS	IS300	2005-01	6	2997 (3.0L) 2JZ-GE
170-2400	PONTIAC	Vibe	2006-03	4	1762 (1.8L) (L) GT
	TOYOTA	Celica	2005-00	4	1762 (1.8L) 2ZZGE GTS
	TOYOTA	Matrix	2005-03	4	1762 (1.8L) XRS 2ZZGE
170-2470	TOYOTA	Camry	2005-02	4	2398 (2.4L) 2AZFE
	TOYOTA	Solara	2005-02	4	2398 (2.4L) 2AZFE
	TOYOTA LIGHT DUTY TRUCKS	Highlander	2005-01	4	2398 (2.4L) 2AZFE
	TOYOTA LIGHT DUTY TRUCKS	RAV 4	2005-04	4	2398 (2.4L) 2AZFE
170-3310	TOYOTA LIGHT DUTY TRUCKS	Tacoma	2004	4	2438 (2.4L) 2RZFE
	TOYOTA LIGHT DUTY TRUCKS	Tacoma	2004	4	2694 (2.7L) 3RZFE
180-2120	VOLKSWAGEN	Passat. Passat Syncro	2005-98	V-6	2771 (2.8L) Gas
180-2200	VOLKSWAGEN	Beetle	2005-98	4	1896 (1.9L) Diesel Turbo
	VOLKSWAGEN	Golf, Golf GTI	2005-00	4	1896 (1.9L) Diesel Turbo w/ Cogged Pulley
	VOLKSWAGEN	Passat. Passat Syncro	2005	4	1968 (2.0L) Turbo Diesel
180-2220	AUDI	A4, A4 Quattro	2005-01	4	1800 (1.8L) AMB Turbo
	AUDI	TT, TT Quattro	2005-00	4	1781 (1.8L)
	VOLKSWAGEN	Beetle	2005-99	4	1781 (1.8L) Inc. Turbo
	VOLKSWAGEN	Beetle	2005-98	4	1984 (2.4L)
	VOLKSWAGEN	Golf, Golf GTI	2005-00	4	1780 (1.8L) Inc. Turbo Gas w/ Cogged Pulley
	VOLKSWAGEN	Golf, Golf GTI	2005-99	4	1984 (2.4L) Gas w/ Cogged Pulley
	VOLKSWAGEN	Jetta, Jetta GLI	2005-00	4	1780 (1.8L) Inc. Turbo Gas w/ Cogged Pulley
	VOLKSWAGEN	Jetta, Jetta GLI	2005-99	4	1984 (2.4L) Gas w/ Cogged Pulley
	VOLKSWAGEN	Passat. Passat Syncro	2005-00	4	1780 (1.8L) Inc. Turbo Gas w/ Cogged Pulley
180-2240	AUDI	A6, A6 Quattro	2004-00	V-6	2671 (2.7L) A6 Quattro Turbo
	AUDI	Allroad Quattro	2005-01	V-8	2671 (2.7L) Turbo
190-1080	VOLVO	S70	2000-98	5	2319 (2.3L) Inc. Turbo w/ 3x4+2spl. Timing Pulley
	VOLVO	S70	2000-98	5	2435 (2.4L) Inc. Turbo w/ 3x4+2spl. Timing Pulley
	VOLVO	V70	2004-98	5	2435 (2.4L) Inc. Turbo w/ 3x4+2spl. Timing Pulley
190-2090	VOLVO	S90	1998-97	6	2922 (2.9L)
	VOLVO	V90	1998-97	6	2922 (2.9L)
190-2120	VOLVO	C70	2004-98	5	2319 (2.3L) B5234FT
	VOLVO	C70	2004-98	5	2435 (2.4L) B5254FS/B52554T7 Inc. Turbo
	VOLVO	S40	2004-00	4	1900 (1.9L)
	VOLVO	S60	2004-01	5	2319 (2.3L) B5234FT Turbo
	VOLVO	S60	2004-01	5	2435 (2.4L) Inc. Turbo
	VOLVO	S60	2004-03	5	2500 (2.5L)
	VOLVO	S70	2000-98	5	2319 (2.3L) Inc. Turbo w/ 2x7spl. Timing Pulley
	VOLVO	S70	2000-98	5	2435 (2.4L) Inc. Turbo w/ 2x7spl. Timing Pulley
	VOLVO	V40	2004-00	4	1900 (1.9L)
	VOLVO	V70	2004-98	5	2435 (2.4L) Inc. Turbo w/ 2x7spl. Timing Pulley
	VOLVO	XC70	2002-99	5	2435 (2.4L)
	VOLVO	XC70	2004-03	5	2500 (2.5L)
	VOLVO	XC90	2004-03	5	2500 (2.5L)
	VOLVO	XC90	2004-03	6	2917 (2.9L)
196-2045	CUMMINS DIESEL	N14		V-6	N14-310, 330, 350, 370, 410 Idler Assembly

Water Pump Interchange List - OE Numbers

Their No.	Our No.	Their No.	Our No.	Their No.	Our No.	Their No.	Our No.
ACURA		12534772	130-7200	MERCURY		VOLKSWAGEN	
19200-RBB-003	135-1500	88893906	130-7260	1F1Z-8501AA	125-1820	078-121-004Q	180-2120
19200-PRB-A01	135-1510	12458935	130-7340	F6DZ-8501FA	125-1820	078-121-006	180-2120
19200-PR7-A03	135-2085	24576952	130-7700	F8DZ-8501AA	125-1820	038-121-011A	180-2200
19200-PV1-A01	135-2090			YW7Z-8501AA	125-1830	038-121-011G	180-2200
19200-PV3-003	135-2090	HONDA		XS2Z-8501CC	125-1910	06A-121-011L	180-2220
19200-P8A-02	135-2380	19200-P08-004	135-1320	3F2Z-8501BB	125-1970	06A-121-011T	180-2220
19200-P8A-03	135-2380	19200-RAA-A01	135-1500	F77Z-8501AD	125-2102		
19200-P8A-A02	135-2380	19200-PNA-003	135-1520	YR3Z-8501AB	125-5950	VOLVO	
		19200-RCA-A01	135-1530	YW7Z-8501BB	125-5970	272476-3	190-2120
AUDI		19200-RDM-A01	135-1530	1L2Z-8501BB	125-5990	271984-7	190-2090
078-121-006A	180-2240	19200-P30-003	135-2200	4S4Z-8501AA	125-6000	271985-4	190-1080
		19200-PLM-A01	135-2420	2S7Z-8501BG	125-6060	272476-3	190-2120
BMW						274216-1	190-2120
1151-7503-884	115-2090	HUMMER		mitsubishi			
1151-7527-910	115-2090	89017439	130-7341	MD979313	148-1780		
				MD979395	148-1780		
CADILLAC		HYUNDAI		MD977503	148-1790		
12529993	130-1840	25100-22010	148-1170	MD979171	148-1790		
12566029	130-5130	25100-23002	146-2020	MD978552	148-1810		
		25100-23010	146-2020	MD309756	148-2280		
CHEVROLET		25100-26015	146-1230	MD978743	148-2320		
89017748	130-1820	25100-26901	146-2070	MD976464	148-2330		
88894044	130-1830			MD976943	148-2330		
89017693	130-7260	INFINITI					
88894345	130-7290	21010-AL525	150-2320	NISSAN			
89017456	130-7290			21010-7Y025	150-2320		
12585226	130-7350	ISUZU		21010-AL526	150-2320		
12591894	130-7350	8-89017-439-0	130-7340	21010-AL527	150-2320		
		8-24576-952-0	130-7700	21010-8J000	150-2340		
CHRYSLER				PONTIAC			
4694307AE	120-4220	JAGUAR		12482903	130-1780		
		EBC10967	113-2120	12537829	130-1780		
CHRYSLER		JLM20915	125-6030	88894344	130-1840		
12371989	130-1480	AJ84817	125-6040	89017467	130-1840		
				89017593	130-7290		
CUMMINS DIESEL		JEEP		88972167	130-7360		
3066330	196-2045	4694307AB	120-4220	88972819	170-2400		
		4694307AC	120-4220				
DODGE		05012366AD	120-4340	SATURN			
4667660AE	120-1300	53021187AA	120-4350	21007655	130-1800		
5086959AA	120-3072	53020873AC	120-4350	21015340	130-1800		
4663732	120-4190			24439798	130-7350		
4781157AA	120-4230	KIA		24467301	130-7350		
53020873AB	120-4350	0247-15-010B	143-2001				
53021187AA	120-4350	0K247-15-010B	143-2001	SUBARU			
4884159AA	120-4360	25100-38002	146-1110	21111-AA110	160-1120		
53021380AK	120-4370	25100-38200	146-1110	21110-AA360	160-2070		
		25100-23021	146-2020				
FORD		LEXUS		SUZUKI			
F0TZ-8501F	125-1620	16110-49156	170-2380	17400-85830	165-1200		
F2UZ-8501A	125-1760			17400-77810	165-2001		
F4DZ-8501A	125-1790	LINCOLN					
XF1Z-8501AA	125-1820	XW4Z-8501AA	125-6030	TOYOTA			
XL5Z-8501AA	125-1850	2R8Z-8501AE	125-6040	16100-09170	130-7360		
XS2Z-8501EA	125-1910	3L3Z-8501CA	125-6050	16100-29175	130-7360		
F68Z-8501A	125-1970	YC2Z-8501BA	125-6050	16110-79095	170-1670		
F7UZ-8501CA	125-1980			16100-59275	170-1840		
F65Z-8501AC	125-2101	MAZDA		16100-29085	170-1920		
F5TZ-8501BRM	125-5721	ZZM7-15-010	125-1850	16100-79225	170-1960		
F81Z-8501DA	125-5920	ZZR1-15-010	125-1850	16100-69398	170-1970		
YC3Z-8501AA	125-5920	1F22-15-010	125-2102	16100-29155	170-2101		
1S7Z-8501AK	125-6000	LF01-15-100	125-6000	16100-69405	170-2103		
YS4Z-8501AK	125-6000	LF52-15-100	125-6000	16100-69408	170-2103		
1W9Z-8501AA	125-6030	AJ03-15-010G	125-6060	16110-79115	170-2107		
		8ABB-15-010A	145-1390	16100-29145	170-2400		
GMC		MERCEDES BENZ		16100-0H010	170-2470		
12532528	130-1820	112-200-1401	147-2220	16100-28040	170-2470		
97216136	130-5980	112-200-1501	147-2250	16100-79445	170-3310		
88893907	130-7090						
89017694	130-7090						

Interchange List

Water Pump Interchange List - Competitors

Their No.	Our No.	Their No.	Our No.	Their No.	Our No.	Their No.	Our No.
AC Delco		252-725	120-4220	WP-9395	170-2380	AW9356	113-2120
251-337	148-1170	252-730	125-1980	WPHD-6059	196-2045	AW9360	148-2280
251-383	130-1480	252-732	130-7090			AW9364	146-1230
251-433	180-2120	252-782	130-7340	Airtex		AW9364	146-2070
251-455	130-1480	252-783	130-7260	AW2045	196-2045	AW9377	180-2220
251-479	130-1830	252-790	170-2380	AW2096	196-2045	AW9378	180-2200
251-490	130-1480	252-795	125-1980	AW4048	125-1620	AW9379	147-2250
251-513	125-1720	252-801	165-2001	AW4069	125-1720	AW9380	147-2220
251-5131	125-1720			AW4089	125-1790	AW9382	190-2120
251-517	125-1620	ASC		AW4091	125-1910	AW9383	135-2380
251-562	130-1780	WP-602	148-1170	AW4094	125-1820	AW9385	165-1200
251-566	130-1820	WP-625	130-1480	AW4095	125-1850	AW9393	143-2001
251-573	130-7200	WP-656	125-1620	AW4102	125-1970	AW9395	170-2380
251-579	130-1820	WP-691	170-1670	AW4105	125-2101	AW9399	146-1110
251-589	130-1830	WP-7164	120-4340	AW4108	125-2102	AW9405	170-2400
251-590	130-7200	WP-726	120-3072	AW4109	125-5920	AW9406	170-2101
251-598	130-1480	WP-777	160-1120	AW4113	125-1830	AW9414	170-2470
251-601	130-7340	WP-782	170-2107	AW4119	125-5950	AW9415	148-1790
251-616	130-7340	WP-837	125-1720	AW4122	125-1980	AW9419	135-2420
251-617	130-1840	WP-841	125-1830	AW4124	125-6030	AW9421	160-2070
251-631	130-7260	WP-844	130-1800	AW4126	125-6000	AW9427	150-2340
251-632	130-7090	WP-875	135-1320	AW4127	125-5990	AW9434	135-1520
252-164	170-1670	WP-882	115-2090	AW4128	125-5970	AW9437	148-2320
252-211	170-1670	WP-9010	135-2090	AW4129	125-6040	AW9444	170-1970
252-235	160-1120	WP-9016	130-1780	AW4130	125-6050	AW9446	180-2240
252-239	135-1320	WP-9018	130-1840	AW4132	125-6060		
252-251	135-2090	WP-9020	130-1820	AW5033	130-1480	Beck Arnley	
252-257	130-1800	WP-9021	130-7200	AW5054	130-1800	131-1949	148-1170
252-258	135-2200	WP-9024	120-1300	AW5062	130-1830	131-2019	170-1670
252-259	180-2120	WP-9031	125-1790	AW5072	130-1840	131-2102	160-1120
252-265	135-2085	WP-9035	125-1910	AW5074	130-7200	131-2118	125-1720
252-267	170-1840	WP-9038	125-1820	AW5075	130-1780	131-2130	115-2090
252-280	125-1830	WP-9044	125-1850	AW5077	130-1820	131-2136	135-1320
252-281	125-1830	WP-9051	170-1920	AW5081	130-7290	131-2137	135-1320
252-284	115-2090	WP-9052	170-1840	AW5087	130-7340	131-2143	135-2090
252-318	120-3072	WP-9080	135-2085	AW5089	130-7260	131-2155	170-1840
252-466	125-1790	WP-9086	145-1390	AW5090	130-7090	131-2158	145-1390
252-467	125-1910	WP-9095	135-2200	AW5092	130-7350	131-2171	135-2200
252-469	125-1820	WP-9097	125-1980	AW5097	130-7700	131-2194	170-1920
252-470	125-1850	WP-9098	125-1970	AW5098	130-5980	131-2195	146-2020
252-474	190-1080	WP-9100	125-2101	AW5099	130-7360	131-2199	180-2120
252-485	125-1980	WP-9101	125-1980	AW5103	130-5130	131-2201	146-1230
252-496	120-1300	WP-9103	120-4190	AW7115	148-1170	131-2204	170-1960
252-499	170-1920	WP-9105	125-5920	AW7145	120-3072	131-2205	120-1300
252-516	125-1830	WP-9106	130-7340	AW7150	120-1300	131-2207	125-1850
252-524	120-4190	WP-9108	120-4220	AW7156	120-4220	131-2209	170-1840
252-526	145-1390	WP-9110	190-1080	AW7161	120-4190	131-2210	170-2103
252-528	135-2200	WP-9119	180-2120	AW7163	120-4350	131-2216	170-1970
252-529	180-2120	WP-9123	190-1080	AW7164	120-4340		
252-540	170-1970	WP-9137	146-2020	AW7165	120-4230	Borg Warner	
252-543	125-5920	WP-9139	146-1230	AW7167	120-4360	P-842	148-1170
252-545	125-2101	WP-9144	125-5950	AW7168	120-4370	P-864	130-1480
252-550	125-1980	WP-9150	170-1960	AW9087	170-1670	P-877	125-1620
252-558	190-1080	WP-9152	170-1970	AW9140	170-2107	P-912	120-3072
252-559	190-2090	WP-9153	170-2103	AW9219	135-2085	P-913	125-1720
252-571	196-2045	WP-9165	125-2102	AW9223	160-1120	P-942	125-1830
252-612	148-1170	WP-9166	125-2102	AW9250	135-1320	P-956	130-1840
252-653	148-2280	WP-9171	148-2280	AW9253	135-2090	P-959	125-1910
252-668	125-1720	WP-9182	130-7260	AW9257	170-1840	P-960	125-1790
252-672	125-1620	WP-9201	135-2380	AW9261	115-2090	P-965	125-2102
252-690	130-1830	WP-9207	135-2420	AW9293	170-1960	P-966	125-5920
252-693	130-1780	WP-9210	120-4230	AW9305	145-1390	P-968	130-1820
252-695	125-5950	WP-9216	125-6000	AW9306	170-1920	P-969	125-1980
252-704	130-1780	WP-9219	125-5990	AW9321	135-2200	P-971	120-1300
252-707	130-1840	WP-9225	125-5970	AW9324	170-1970	P-977	130-7200
252-709	146-2020	WP-9228	130-7350	AW9325	170-2103	P-978	130-1780
252-711	130-1820	WP-9231	165-2001	AW9333	180-2120	P-979	125-2101
252-713	146-1230	WP-9234	130-7700	AW9339	190-1080	P-982	125-1970
252-716	130-1830	WP-9240	120-4350	AW9340	190-2090	P-983	125-1850
252-717	130-7200	WP-9249	180-2200	AW9342	165-2001	P-984	125-1820
252-721	130-1480	WP-9254	143-2001	AW9353	146-2020	P-990	125-1830

Interchange List

Water Pump Interchange List - Competitors

Their No.	Our No.	Their No.	Our No.	Their No.	Our No.	Their No.	Our No.
Borg Warner (Cont.)		55-53626	135-2420	18-1607	165-2001	FP2367	190-1080
P-992	125-1980	55-73128	145-1390	18-1613	180-2220	FP2369	190-2090
P-999	120-4190	55-73130	146-2020	18-1614	180-2200	FP2372	135-2200
P-2108	180-2120	55-73136	143-2001	18-1615	143-2001	FP2375	145-1390
P-2314	170-1670	55-73140	146-1110	18-1627	120-4350	FP2377	180-2120
P-2359	160-1120	55-73412	160-1120	18-1629	120-4230	FP2383	125-1830
P-2366	135-2085	55-73615	148-2280	18-1634	125-6000	FP2389	120-4190
P-2367	135-2090	55-83320	115-2090	18-1635	125-5990	FP2402	146-2020
P-2370	115-2090	55-83326	147-2220	18-1636	125-5970	FP2404	146-1230
P-2376	135-1320	55-83414	180-2120	18-1637	130-7350	FP2410	125-5950
P-2419	170-2103	55-83615	190-1080	18-1638	130-7700	FP2441	125-5950
P-2423	170-1970	55-83617	190-2090	18-1644	170-2400	FP2452	120-4220
P-2438	170-1840	55-83618	180-2220	18-1646	135-2420	FP2478	135-2380
P-2445	190-1080	55-83619	180-2200	18-1685	146-1110	FP2491	146-1110
P-2446	190-2090	55-91512	196-2045	18-1694	125-6050	FP2513	170-2101
P-2462	135-2200			18-1702	113-2120	FP2520	143-2001
P-2464	145-1390	Eastern		18-1713	170-2470	FP2525	125-5970
P-2466	180-2120	18-212	148-1170	18-1714	148-1790	FP2526	120-4350
		18-438	170-1670	18-1715	148-2320	FP2527	120-4340
		18-439	130-1480	18-1726	135-1520		
		18-472	125-1620	18-1727	135-1510	Motorcraft	
Cardone		18-614	170-2107	18-1737	146-2020	PW-230	125-1620
55-11129	130-1830	18-673	160-1120			PW-262	125-1620
55-11130	130-7200	18-701	125-1720	Federal Mogul Mexico		PW-265	125-1620
55-11311	130-1820	18-707	135-1320	P-842	148-1170	PW-278	125-1720
55-11313	130-7260	18-825	135-2090	P-864	130-1480	PW-322	125-1720
55-11314	130-7090	18-852	130-1830	P-877	125-1620	PW-324	125-1820
55-13127	130-1480	18-888	130-1800	P-912	120-3072	PW-330	125-1970
55-13134	130-1780	18-913	135-2085	P-913	125-1720	PW-336	125-2101
55-13138	130-7350	18-925	170-1840	P-942	125-1830	PW-350	125-1980
55-13142	165-2001	18-1066	115-2090	P-959	125-1910	PW-351	125-1980
55-13311	130-7700	18-1109	120-3072	P-960	125-1790	PW-352	125-5920
55-13411	130-7340	18-1121	135-1320	P-968	130-1820	PW-356	125-2102
55-13515	130-1840	18-1321	125-1910	P-983	125-1850	PW-359	125-1830
55-16112	130-1800	18-1323	125-1820	P-984	125-1820	PW-366	125-5920
55-21313	125-1620	18-1324	125-1850	P-996	120-1300	PW-371	125-1980
55-21316	125-5920	18-1326	130-1840			PW-373	125-1910
55-23131	125-1790	18-1379	125-1980	Federal Mogul / Carter		PW-381	125-1910
55-23134	125-1820	18-1381	130-7200	FP1617	148-1170	PW-383	125-1970
55-23135	125-1970	18-1382	130-1780	FP1848	170-1670	PW-384	125-1820
55-23137	125-1830	18-1384	130-1820	FP1869	125-1620	PW-386	125-5950
55-23139	125-5950	18-1385	120-1300	FP1877	130-1480	PW-387	125-1980
55-23140	125-6000	18-1390	170-1920	FP1883	130-1830	PW-389	125-1850
55-23141	125-5970	18-1420	125-1970	FP2013	170-1670	PW-395	125-1850
55-23317	125-1850	18-1428	125-1830	FP2019	160-1120		
55-23320	125-2101	18-1439	120-4190	FP2055	125-1720	NAPA	
55-23321	125-2102	18-1441	145-1390	FP2065	130-1800	55-2045	196-2045
55-23324	125-1980	18-1443	135-2200	FP2075	135-1320	55-4048	125-1620
55-23325	125-5990	18-1444	180-2120	FP2162	135-2090	55-4069	125-1720
55-23512	125-1910	18-1476IP	196-2045	FP2166	170-1840	55-4102	125-1970
55-23613	125-1720	18-1483	170-2103	FP2169	115-2090	55-4105	125-2101
55-31411	120-3072	18-1484	170-1970	FP2207	135-2085	55-4108	125-2102
55-33125	148-1170	18-1487	125-5920	FP2249	196-2045	55-4109	125-5920
55-33140	120-4230	18-1488	125-2102	FP2262	120-3072	55-4110	125-1980
55-33315	120-4340	18-1489	125-2101	FP2287	125-1790	55-4113	125-1830
55-33418	120-4350	18-1503	190-1080	FP2288	125-1910	55-4119	125-5950
55-33613	120-1300	18-1536	190-2090	FP2290	125-1820	55-4122	125-1980
55-33615	120-4220	18-1548	148-2280	FP2291	125-1850	55-5033	130-1480
55-33711	120-4190	18-1555	125-5950	FP2293	130-1840	55-5074	130-7200
55-43145	170-1960	18-1561	146-2020	FP2306	170-1920	55-5089	130-7260
55-43148	170-2380	18-1564	146-1230	FP2307	120-1300	55-5090	130-7090
55-43149	170-2400	18-1585	120-4220	FP2320	130-7200	55-7115	148-1170
55-43155	170-2101	18-1587	125-1980	FP2324	130-1780	55-7145	120-3072
55-43414	170-1840	18-1588	130-7260	FP2326	130-1820	55-7156	120-4220
55-43419	170-1920	18-1589	130-7090	FP2328	125-1980	55-7161	120-4190
55-43614	170-1670	18-1598	170-2380	FP2348	170-1970	55-9019	180-2120
55-53413	135-2085	18-1601	130-7290	FP2349	170-2103	55-9087	170-1670
55-53416	170-1970	18-1602	130-7340	FP2354	125-1970	55-9219	135-2085
55-53417	170-2103	18-1603	135-2380	FP2358	125-2101	55-9223	160-1120
55-53421	135-2380	18-1605	120-4340	FP2364	125-2102	55-9250	135-1320
55-53618	135-1320	18-1606	125-6030	FP2365	125-5920	55-9253	135-2090
55-53620	135-2090						
55-53623	135-2200						

Water Pump Interchange List - Competitors

Their No.	Our No.	Their No.	Our No.	Their No.	Our No.	Their No.	Our No.
NAPA (Cont.)							
55-9257	170-1840						
55-9261	115-2090						
55-9305	145-1390						
55-9306	170-1970						
55-9321	135-2200						
55-9322	190-2090						
55-9324	170-1970						
55-9325	170-2103						
55-9333	180-2120						
55-9339	190-1080						
55-9340	190-2090						
55-9360	148-2280						
55-9364	146-1230						
55-9395	170-2380						

Interchange List

Water Pump Pictures



115-2090



120-1300

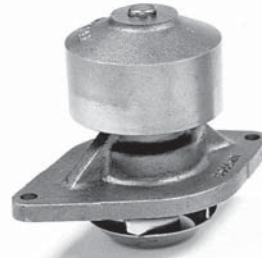

120-3072

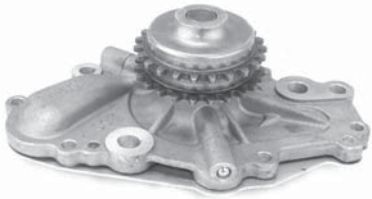

120-4190



120-4220



120-4230

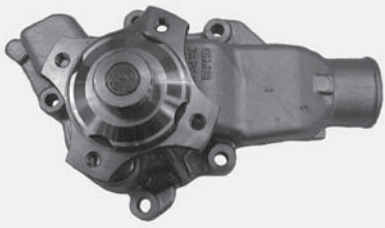

120-4340

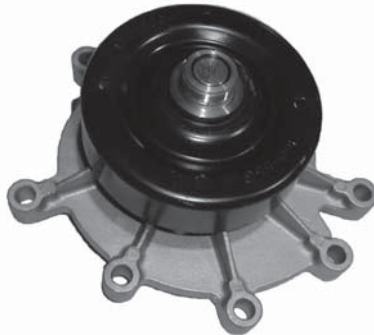

120-4350



120-4360



120-4370



125-1620



125-1720

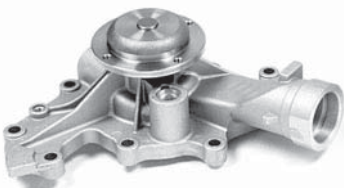

125-1790



125-1820

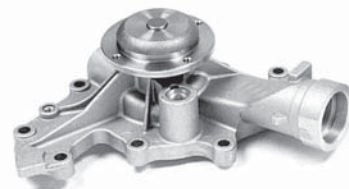

125-1830

Water Pump Pictures



125-1850



125-1910



125-1970



125-1980



125-2101

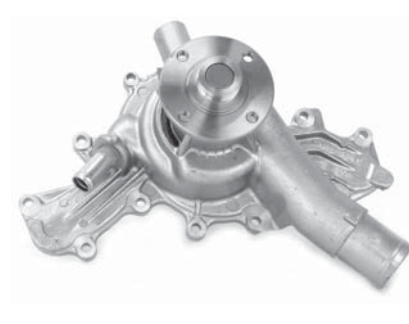

125-2102

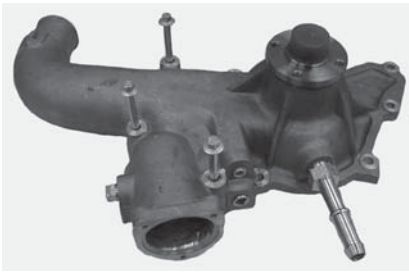

125-5721



125-5920



125-5950



125-5970



125-5990



125-6000



125-6030



125-6040



125-6050

Pictures

Water Pump Pictures

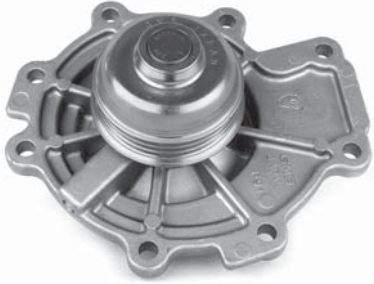

125-6060



130-1480

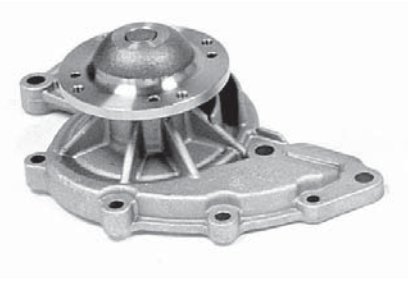

130-1780

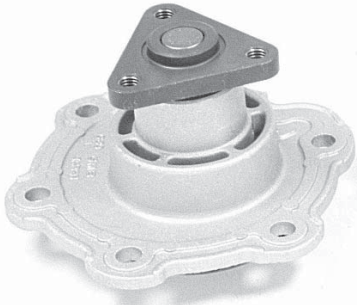

130-1800



130-1820



130-1830



130-1840



130-5130

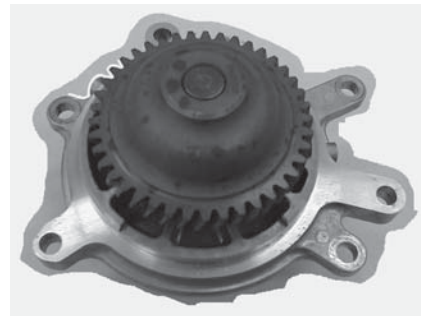

130-5980



130-7090

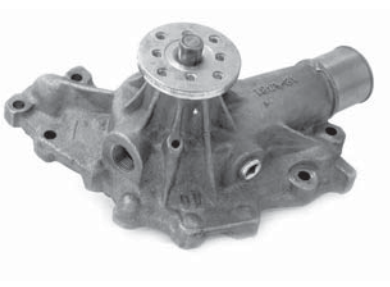

130-7200

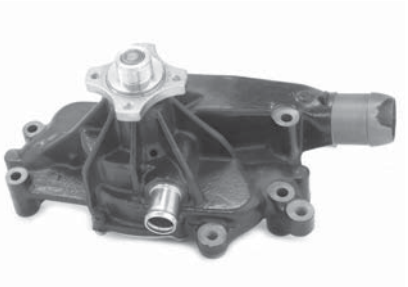

130-7260

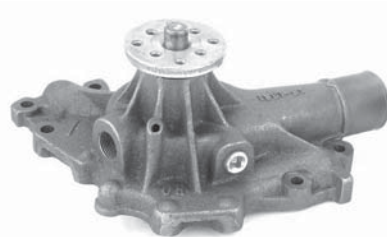

130-7290



130-7340

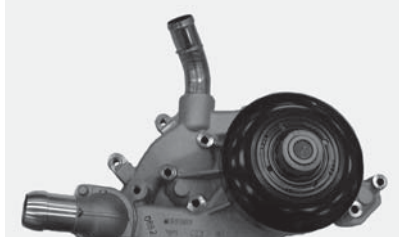

130-7341

Water Pump Pictures



130-7350



130-7360



130-7700

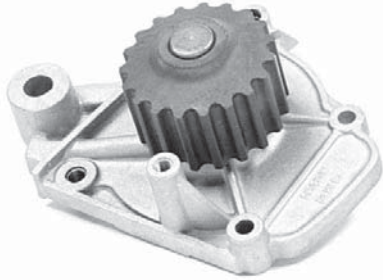

135-1320



135-1500



135-1510



135-1520



135-1530

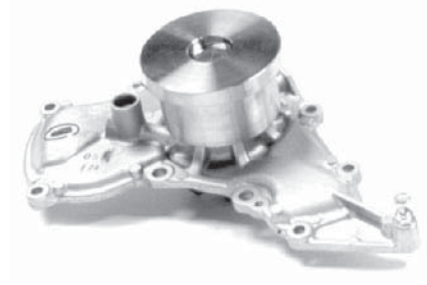

135-2085

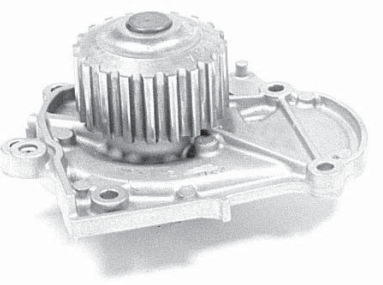

135-2090

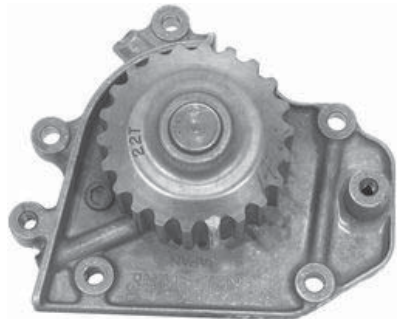

135-2200

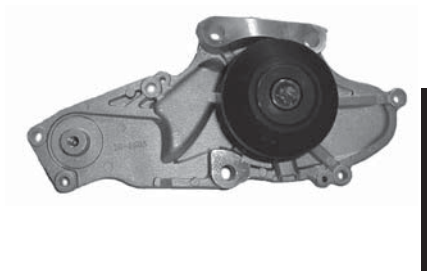

135-2380

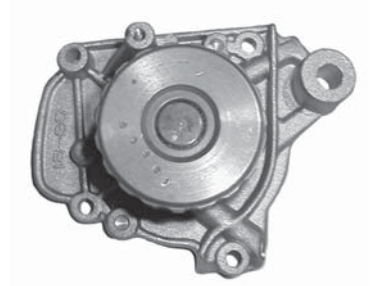

135-2420

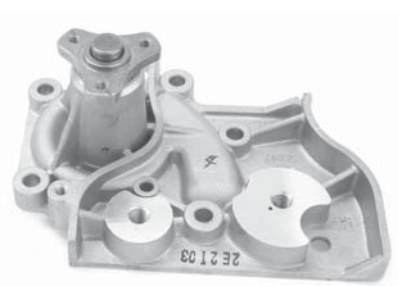

143-2001

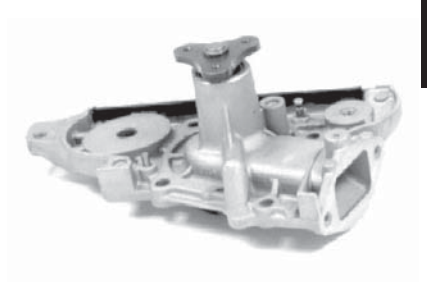

145-1390

Pictures

Water Pump Pictures

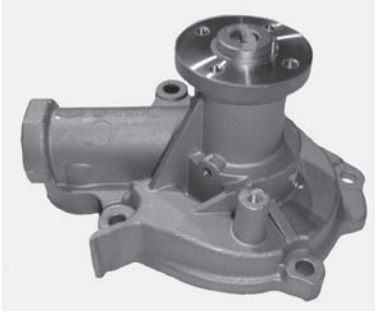

146-1110

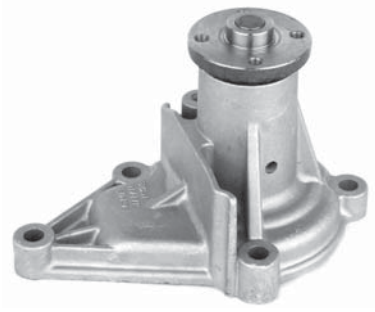

146-1230



146-2020

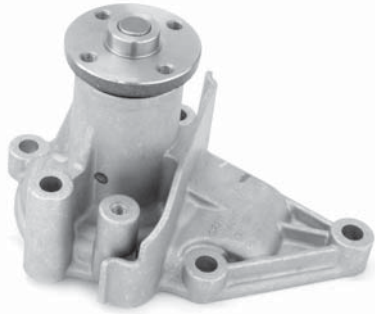

146-2070

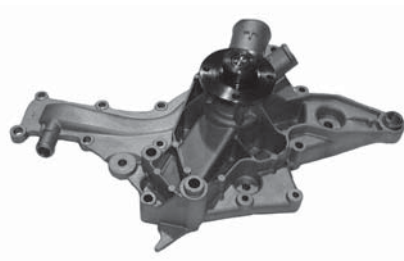

147-2220

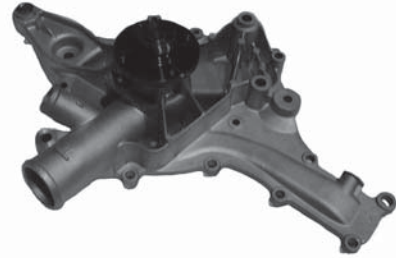

147-2250

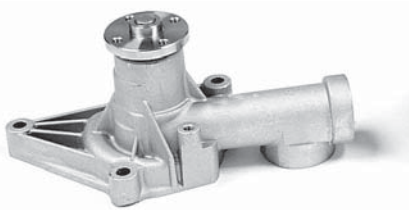

148-1170

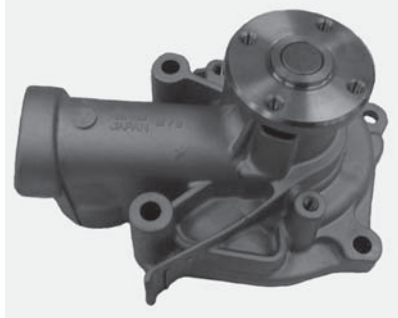

148-1780

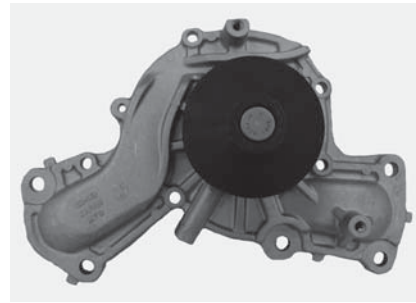

148-1790

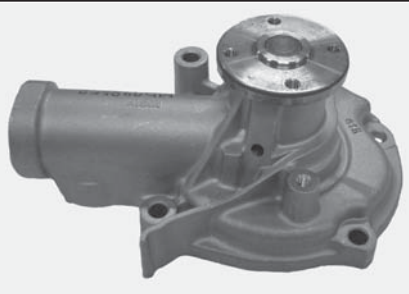

148-1810

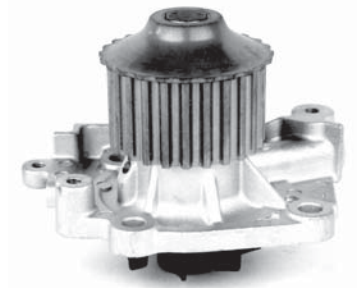

148-2280

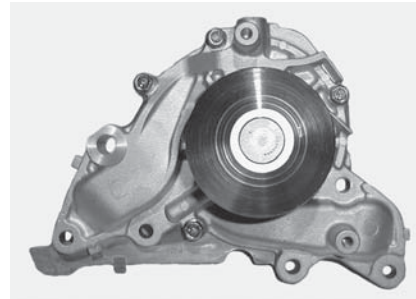

148-2320



150-2340

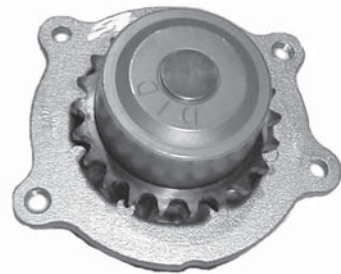

160-2070

Water Pump Pictures



165-1200



165-2001

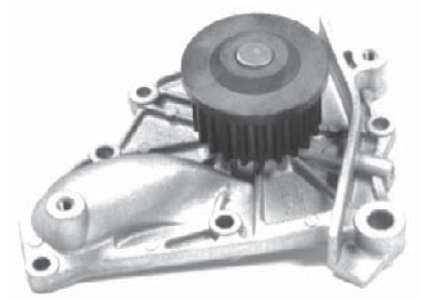

170-1670

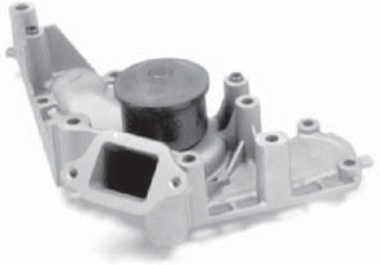

170-1840

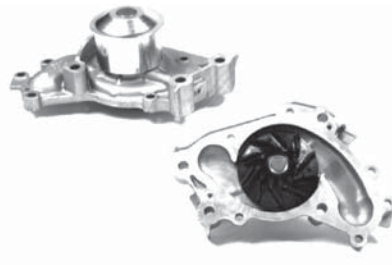

170-1920



170-1960

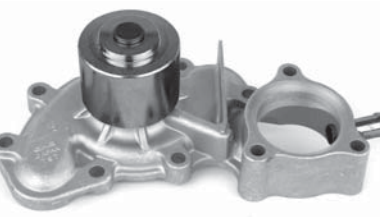

170-1970



170-2101

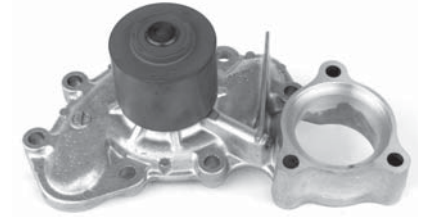

170-2103

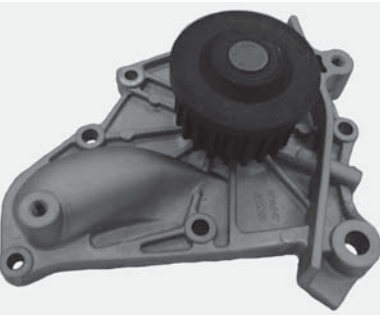

170-2107



170-2380



170-2400

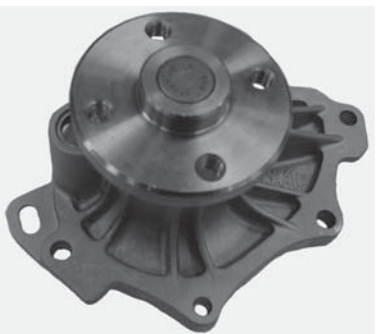

170-2470



170-3310

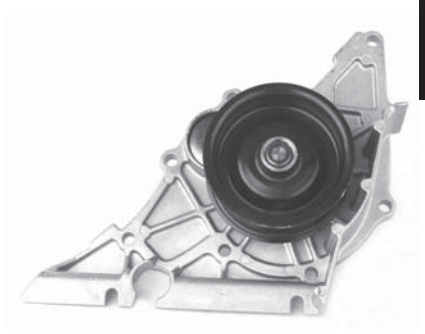

180-2120

Pictures

Water Pump Pictures



180-2200



180-2220

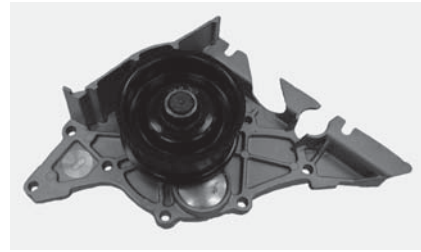

180-2240

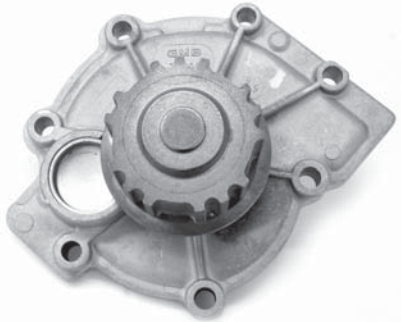

190-1080

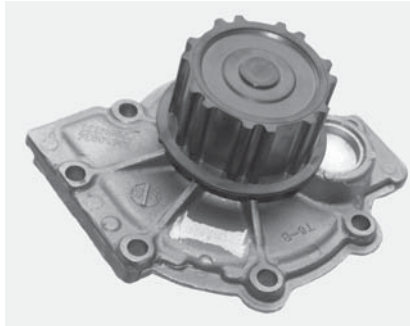

190-2090

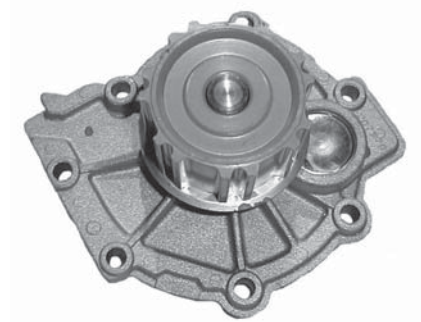

190-2120



196-2045